

dCS P8i
Upsampling SACD/CD Player

User Guide
Software Release 1.1x
July 2006

© *dCS* Ltd. 2005, 2006

Price UK £8.00 / Euro 12.00

All rights reserved. No part of this publication may be reproduced, stored in or introduced into a retrieval system, or transmitted in any form, or by any means (electronic, mechanical, photocopying, recording or otherwise) without the prior written permission of *dCS*¹. Any person who does any unauthorised act in relation to this publication may be liable to criminal prosecution and civil claims for damages.

Information contained in this manual is subject to change without notice, and whilst it is checked for accuracy, no liabilities can be accepted for errors.

¹ *dCS* is Data Conversion Systems Ltd. Company registered in England No. 2072115.

USING THE *dCS P8i* FOR THE FIRST TIME

Congratulations on purchasing your *dCS P8i*.

Before using your unit, please read this section and the Step by Step Guide. This will enable you to set the unit up quickly and safely with your hi-fi system.

From time to time, dCS will release updated software on CD that you can install yourself using the **CD Update** feature. Please check our web-site occasionally to see if new *P8i* software is available, or consult your dealer.

What's in the box?

Check that the box contains the following items:

- *dCS P8i*
- Control Summary
- Power cable
- 2 spare fuses
- Remote control unit
- Remote control guide
- 3 x AAA batteries
- 1.5mm Allen Key for the remote control unit

Check the contents of the inner carton against the list above. Notify your dealer as soon as possible if anything is missing or damaged. We suggest that you retain the original packaging for possible future use. If this is not possible, replacement packaging can be ordered from *dCS* or our distributors. Details can be found on our web site at www.dcsLtd.co.uk.

Safety Notice

Your *dCS P8i* contains no user serviceable parts. **DO NOT** attempt to open the case as there are potentially dangerous voltages present inside. In the event of the unit developing a fault, please contact your dealer in the first instance. If you need more help, contact dCS.

Laser Radiation Hazard

The *dCS P8i* is a Class 1 Laser Product, it complies with U.S. FDA 21CFR subchapter J. In normal use, there is no risk of exposure to laser radiation.

IMPORTANT!

*The metal top cover must only be removed by authorised service personnel.
The cover protects the user from indirect exposure to visible and invisible laser radiation, as well as risk of electric shock.*

Removing the Transit Screws

The transit screws clamp the mechanism to reduce the risk of shipping damage. They must be removed before the unit is used.

Lift the unit out of the packaging, turn it upside-down and place it on a table top. Identify the two transit screws from the following drawing.

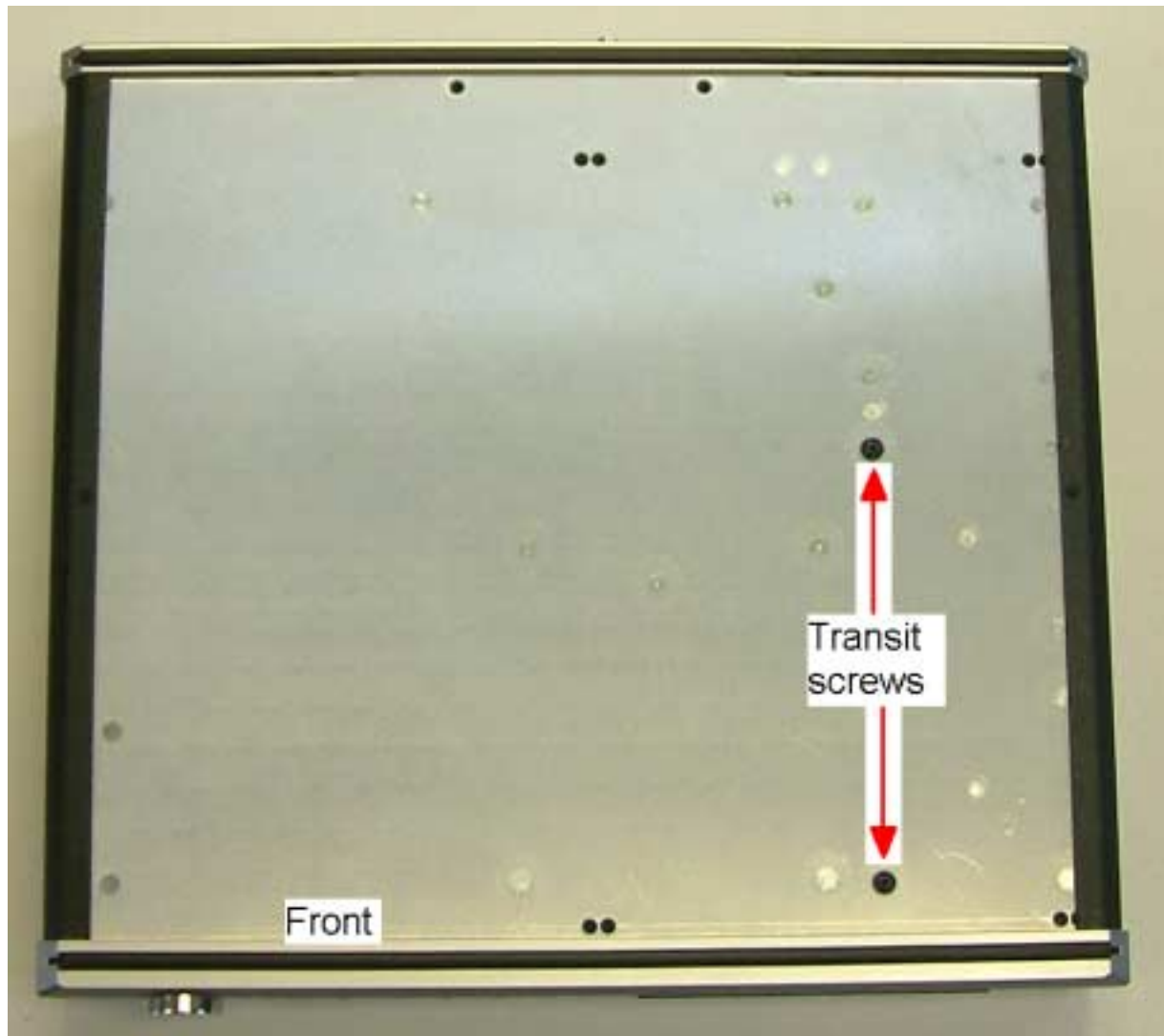

Using a flat headed screwdriver, unscrew the two transit screws and put them in a safe place.

IMPORTANT!

*If you intend to transport the unit further than the next room, replace the transit screws – they need to be secure **BUT NOT OVER-TIGHT**. Units that are returned for repair without transit screws correctly fitted will be subject to a repair charge.*

Mains Voltage Setting

Before connecting the power cable to your *P8i* for the first time, please check that it has been set to the correct operating voltage for your mains supply. The unit's voltage setting is shown on the label beneath the mains inlet on the rear panel. If this does not match your local supply voltage, **DO NOT** attempt to use the unit. Contact your dealer to have the unit reset. Using the *P8i* with the wrong mains setting for your local supply may result in serious damage to the unit and will invalidate the warranty. Do not attempt to reset the voltage yourself.

Power Cables

If you wish to use a power cable other than the one supplied, please ensure that it is a good fit to the mains inlet, is not too fat, too stiff or too heavy.

Mains Conditioners

We do not recommend the use of mains conditioners. However, if you do wish to use a mains conditioner with variable voltage and frequency, we recommend that you set the voltage to match your local voltage and the frequency to either 50 or 60Hz ONLY.

IMPORTANT! *Damage caused to your P8i by misuse of a mains conditioner or by a malfunctioning mains conditioner is not covered by the warranty.*

Positioning the unit

Place the *P8i* on a firm, vibration free base, allowing convenient connection to the other parts of your system. For best results avoid siting the *P8i* either directly on or underneath preamplifiers or tuners. To prevent overheating, we recommend that you leave some free space around the unit to allow for ventilation.

STEP-BY-STEP GUIDE

This section guides you through setting up the unit for basic operation.

Preliminaries

The Control Summary sheet details the menu structure and outlines the use of the front panel controls. A comprehensive user manual will be available free of charge from our web-site at www.dcsLtd.co.uk or a bound copy can be ordered from our web site.

STEP 1 – Connecting the P8i using the Analogue Outputs

If you prefer to use an external DAC, go to step 2.

Most owners will make use of the P8i's internal Ring DAC to drive the power amplifier directly.

The P8i has one pair of balanced analogue outputs on XLR connectors (Left and Right) and one pair of unbalanced analogue outputs on two RCA phono connector (Left and Right).

- Connect either the balanced or the unbalanced analogue outputs on the P8i to the matching inputs on your preamplifier / power amplifier with suitable audio cables. Both sets of outputs may be used simultaneously, if required.
- Connect the power amplifier to your loudspeakers.

STEP 2 – Connecting the P8i using the Digital Outputs

If you are using the P8i's internal DAC, go to step 3.

When playing CDs, 16bit / 44.1kS/s digital data will appear on the **AES OUT** and **RCA OUT** connectors, which can be used to drive an external DAC.

- Connect one of the AES or RCA digital outputs on the P8i rear panel to the matching inputs of the DAC using suitable screened digital cables.
- Press the **MENU** button and use the arrow buttons to scroll to the Digital Out page. If this is set to Off, press the **MENU** button to change to On.
- Connect the analogue outputs of your DAC to the matching inputs on your preamplifier / power amplifier.
- Connect the power amplifier to your loudspeakers.

STEP 3 – Connecting to the Digital Inputs

You can use the P8i's internal Ring DAC to convert digital data from an external source to analogue. In this release, the unit will lock to 32, 44.1 or 48kS/s and process word lengths up to 24 bits.

- Connect the external source (such as a DAB radio or DVD player) to either the **AES IN** or **RCA IN** connector on the P8i back panel, using suitable screened digital cables. You can use both digital inputs if you wish.
- Connect the analogue outputs of your DAC to the matching inputs on your preamplifier / power amplifier.
- Connect the power amplifier to your loudspeakers.

STEP 4 – Powering up

- Connect the power cable supplied to the power inlet on the **P8i** rear panel. If you are using a power cord other than the one supplied with the **P8i**, make sure that it is a good fit to the mains inlet and is not too large or heavy as to cause damage (see “Power cables” on page 4). Plug the other end into a convenient power outlet. Set the power switch beside the power inlet to the on position (**I**).
- Press the **Standby** button briefly. Wait several seconds while the **P8i** configures itself. The buttons light up in blue showing that the unit is booting up. After a few seconds the blue lights turn off. Unit displays **dCS P8i, Welcome** and then **Loading**. Once booted up, the colour of the buttons changes to green, signifying that there is no disc in the player, and the unit should display **No Disc**.
- Make sure the volume on your **P8i** and amplifier is set to a low level before operation.

The first time you use the unit, it is a good idea to ensure it is set to a known state, as follows:

- Press the **MENU** button and use the arrow buttons to scroll to the **Factory** page of the menu. Press the **MENU** button again to select this option. The unit will reset itself.

STEP 5 – Inserting and playing a Disc

- Press the **Stop/Eject** button. The display will show **Opening**, the drawer will open and then the display will show **Open**.
- Place the disc onto the tray and press the **Stop/Eject** button again. The display will show **Closing, Loading, Read TOC, Checking** and will then build a table of contents displaying **1-5, 6-10**, etc. The disc will be identified as CD or SACD. Either the **CD** or the **SACD** indicator will light. In this release, the unit will play the SACD layer of a hybrid disc by default. The colour of the buttons changes depending on the type of disc you choose to play, red for a CD layer or lilac for an SACD layer.
- Press the **Play/Pause** button. Turn the volume to a comfortable level. You should have audio.
- Press the **Play/Pause** button to pause playing, press again to resume playing.
- Press the **Next Track** or **Previous Track** buttons to skip to another track.

IMPORTANT!

*Please be patient, do not overload the unit with commands. If too many **Previous Track** commands are sent, the unit may freeze at track 1. To correct this, press the **Next Track** button once to go to track 2.*

- Press the **Stop/Eject** button to stop the disc. Press it again to open the tray.
- Enjoy the music!

Oops! There is a disc stuck inside!

If you load a disc that cannot be read (such as a CD upside-down, a DVD or a damaged/dirty disc), don't worry. The **P8i** will display **Reading** and will try to read the disc for about 40 seconds. Wait until the display changes to **No Disc**, then open the tray with the **Stop/Eject** button.

STEP 6 – Using an external source

If you connected an external source to the **P8i** in STEP 3, turn it on and select it as follows:

- Press the **MENU** button and use the arrow buttons to scroll to the **Source** menu page. Press the **MENU** button again to select either the **AES** or **RCA** input.

Either the **AES** or **RCA** indicator will illuminate. The unit will detect the sample rate of the source (32, 44.1 or 48kS/s only), then display the source word length and sample rate on the left side of the display (e.g. **16/44.1k**).

- Turn the volume to a comfortable level. You should have audio.
- Enjoy the music!

IMPORTANT!

When using the digital inputs, the CD controls are disabled.

THE HARDWARE – CONTROLS AND CONNECTORS

This section briefly explains the layout of the front and the rear panel and what the symbols stand for.

Front Panel

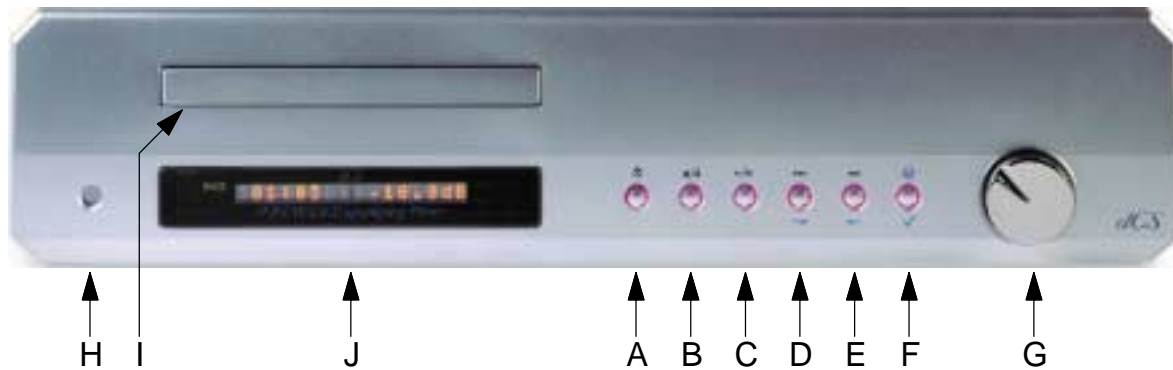

Key to the front panel

- A - Standby Button
- B - Stop / Eject Button
- C - Play / Pause Button
- D - Previous Track / Menu Step Back Button
- E - Next Track / Menu Step Forward Button
- F - Menu / Select Button
- G - Rotary Control
- H - Remote Control Sensor
- I - SACD / CD Drawer
- J - Main Display

A – Standby

- To power up or switch out of standby mode, press the **Standby** button briefly.
- When you have finished listening, press the **Standby** button briefly to set the unit to standby mode. The **Standby** button will glow red and the rest of the display will turn off.
- To switch off completely, hold down the **Standby** button for a few seconds until it glows lilac, then release it. Please wait at least 10 seconds before switching on again.

B – Stop / Eject /

- When there is no disc in the player, or if the disc is stopped, press this button to open the tray.
- When the tray is open, press this button to close the tray.
- When a disc is playing, press this button to stop the disc.

C – Play / Pause /

- With a disc loaded, press this button to start playing.
- Press it to pause and press again to resume playing.

D – Previous Track / Menu Step back

- Press the **Previous Track** button briefly to skip to the previous track.
- If the disc is playing, the first touch on this button will return to the start of the current track, a second push on this button will take you to the beginning of the previous track. It is recommended to use the numeric keypad on the remote control to select tracks e.g. If track 5 on a disc is being played but you want to go back to track 3, just press 3 on the remote control keypad.
- When the menu is open, this button is used for paging backwards through the menu.

E – Next Track / Menu Step Forward

- Press the **Next Track** button briefly to skip to the next track.
- When the menu is open, this button is used for paging forwards through the menu.

F – Menu / Select

- Press the **Menu** button to open the menu and change or select settings in the menu.
- When the **Menu** button is pressed, the light pipes switch off, except the menu button, and the two buttons used to page forward and backwards through the menu.

G – Rotary Control

- Use the **Rotary Control** to turn the volume up or down
- While the menu is open, use the **Rotary Control** to page forwards and backwards through the menu.
- When the **Balance** option has been selected, use the **Rotary Control** to change the balance settings.

H – Remote Control Sensor

The remote control sensor is an infra-red receiver and requires a direct line of sight to receive signals from the remote control transmitter.

I – SACD / CD Tray

If the tray is open when the unit is on and you press the **Standby** button, the tray will close automatically before the unit enters standby mode.

J – Main Display

The main display tells you what the **P8i** is doing.

- While playing a disc, the track number, the track time and the volume setting are usually displayed.
- While adjusting the channel balance, the track time and the L/R balance settings are displayed.
- When accessing the menu, menu options are displayed.

Rear Panel

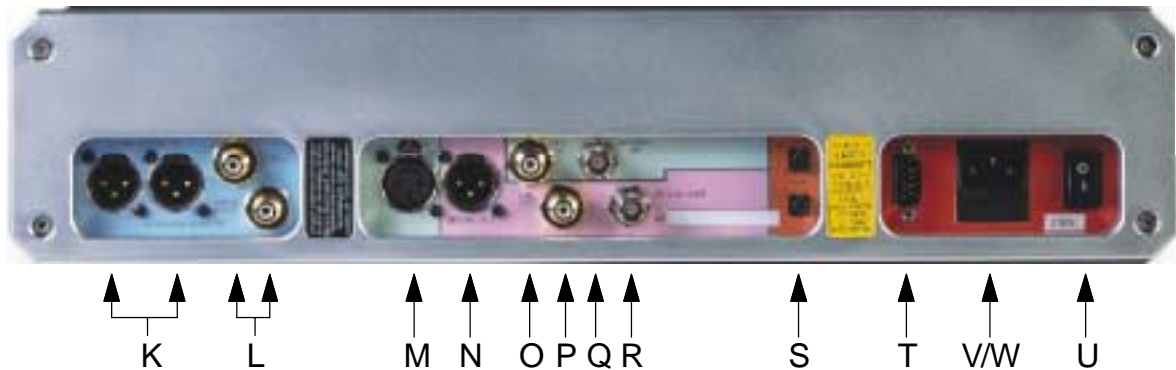

Key to the Rear Panel

- K – Balanced analogue outputs L & R on XLR male connectors
- L - Unbalanced analogue outputs L & R on RCA phono connectors
- M – AES Digital Input on XLR female connector
- N – AES Digital Output on XLR male connector
- O – SPDIF Digital Input on RCA connector
- P – SPDIF Digital Output on RCA connector
- Q – Word clock Digital Input
- R – Word clock Digital Output
- S – Power link In and Out
- T – Software Upgrade connector, 9-way 'D' type
- V – Mains Fuse Holder
- W – IEC Power Inlet
- U – Power Switch

THE MENU

The menu gives you access to a range of additional features. It also allows access to new features and performance enhancements that can be added at a later date by software upgrades.

Using the menu

The menu is controlled by 3 buttons:

- The **Menu** button opens the menu and with the menu open acts as the **Select** button.
- The **Step Forward** button pages forward through the menu.
- The **Step Back** button pages backward through the menu.

When the **Menu** button is pressed, the light pipes switch off, except the **Menu** button itself, and the two buttons that drive the menu.

You can also use the **Rotary control** to page backwards and forwards through the menu. Successive presses of the **Step Forward** or **Step Back** button page through the menu. You cannot go directly to any particular page.

There are two ways to close the menu:

- You can use either **Step** button until the display shows **Exit** and then press **Select**.
- 5 seconds after your last command the menu will time-out and the **P8i** will revert to normal operation.

Menu Sequence

The following explanation briefly deals with the Menu pages in the sequence they occur in the Menu, and this summarised in the Control Summary.

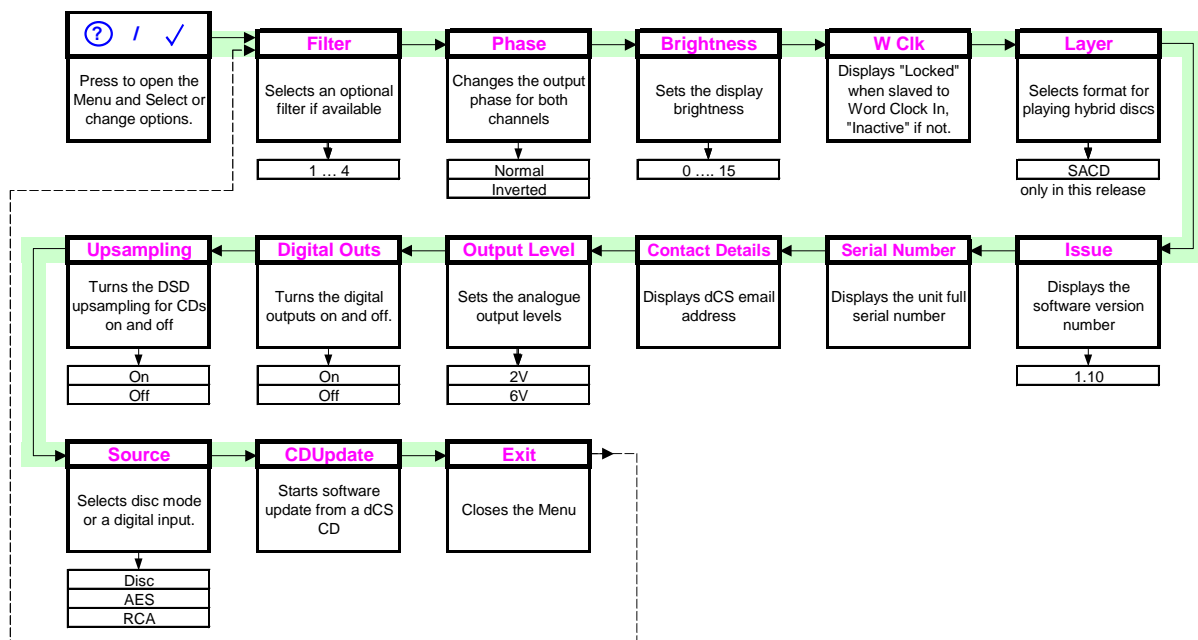

Filter

While upsampling a CD or playing an SACD, the *P8i* offers a choice of 4 interpolation filters. The filters offer different trade-offs between signal bandwidth and out-of-band noise level (which is inherent in the 1-bit nature of DSD).

Filter 1 gives the widest bandwidth (about 70kHz) with the highest level of out-of-band noise. This is the usual setting.

Filter 2 gives a slightly narrower bandwidth with a lower level of out-of-band noise.

Filter 3 gives a slightly narrower bandwidth again and less out-of-band noise than **Filter 2**.

Filter 4 is intended for troubleshooting, not listening – it has a very low level of out-of-band noise and a 20kHz bandwidth.

Selecting the best filter for your system is simply a matter of cycling through Filters 1, 2 and 3 as you play a disc and choosing the one that you think sounds best. The best choice will depend on your system, the tonal qualities of the music and your taste.

To choose a filter press the **Menu** button and cycle through the menu with the **Step Back or Step Forward** button until **Filter** is displayed. Now press the **Select** button repeatedly to scroll through the different filter options.

Phase

This option allows you to invert (reverse the phase of) both channels to correct a system phasing error.

Brightness

This adjusts the brightness of the main display, with settings between **15** (brightest) and **0** (off, unless something is touched).

The light pipes around the buttons turn off when the display brightness is set to **0** and stay on at settings **1** to **15**.

Word Clock (WClk)

This shows the status of the **Word Clock Input**, displaying **WClk : Locked** when the unit is locked to an external Word Clock signal or **WClk : Inactive** if not.

Layer (CD, SACD)

IMPORTANT!

*The **Layer** feature is not active in this software release. The SACD layer of hybrid discs will be played.*

Issue – Software Issue State

This displays the issue number of the software fitted to your unit. You will need to check this if you are considering a software upgrade.

Serial Number – Unit Serial Number

This displays the full serial number, including the hardware configuration code. We will need this information to assemble upgraded software to suit your unit.

Contact Details – Contact Information

This displays dCS email address and web-site URL.

Output Level

The Output levels should be set to suit your system – there are two levels: 6V (high) or 2V (low). The difference between the two settings is 9.5dB.

For best results, the *P8i* volume control should be set to no lower than –20.00dB for normal listening levels with typical music. We suggest that you start with 2V and increase the level to 6V if this is inadequate.

Before changing the output level to 6V, please insure you are not playing music at a high level – the extra 9.5dB is noticeably louder.

Digital Output

This option allows you to turn the **Digital & W/Clock Outputs** Off or On.

Upsampling

This option allows you to turn the DSD upsampling Off or On when playing CDs.

Source

This page allows you to use the *P8i* as a DAC to convert data from external sources (such as a DVD player or DAB radio) to analogue. There are 3 settings:

- **Disc** – the unit operates as a CD/SACD player.
- **AES** – the unit accepts digital data at 32, 44.1 or 48kS/s from the **AES** input.
- **RCA** - the unit accepts digital data at 32, 44.1 or 48kS/s from the **RCA** input.

IMPORTANT! *When the unit is set to **AES** or **RCA**, the CD controls are disabled. If you want to open the CD tray, set the **Source** page to **Disc** first.*

IMPORTANT! *In this release, external sources are not upsampled.*

When the external inputs are in use, the following pages disappear from the menu: **Filter**, **WClk**, **Layer**, **Digital Outputs**, **Upsampling** and **CD Update**.

CDUpdate – Software Update by CD

Future releases of software can be loaded via a CD using this menu page. Detailed instructions will be supplied with the software update CD.

Exit – End of the Menu

Select this page to come out of the menu and return to the normal display.

REMOTE CONTROL

Fitting or replacing the Batteries in the Remote Control

For safety reasons, the remote control is supplied with the 3 batteries packed separately. Any replacement batteries must be type AAA, MN2400 or equivalent alkaline leak-proof batteries.

Opening the battery compartment and removing the batteries

Turn the Remote Control unit over and remove the 2 screws shown in the figure below using the Allen key supplied. Lift off the battery cover.

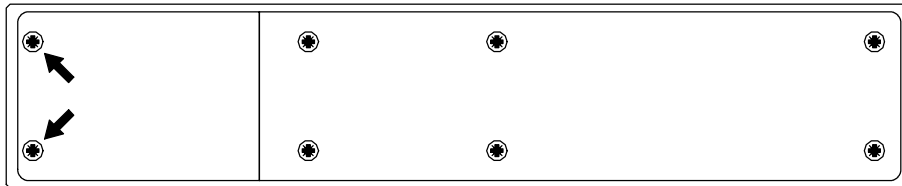

To remove discharged batteries, press the + end back against the spring and pull that end out of the unit. A small key or screwdriver may be used if the battery is a tight fit. Dispose of the discharged batteries safely

Fitting new batteries and closing the case

To fit a new battery, press the – end (the flat end) against one of the spring contacts in the battery holder then press the battery into its slot. Battery polarity is indicated on the battery holder and on the diagram below. Always fit a complete set of 3 new batteries.

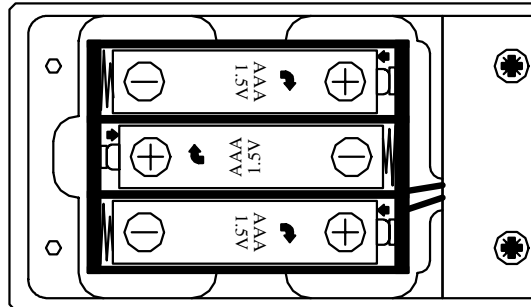

To re-assemble the case, fit the battery cover, ensuring the side with the recessed holes is outward. Replace the 2 screws, do not over-tighten them as this can damage the screw heads and the remote case. The Remote Control is ready to use.

Using the Remote Control

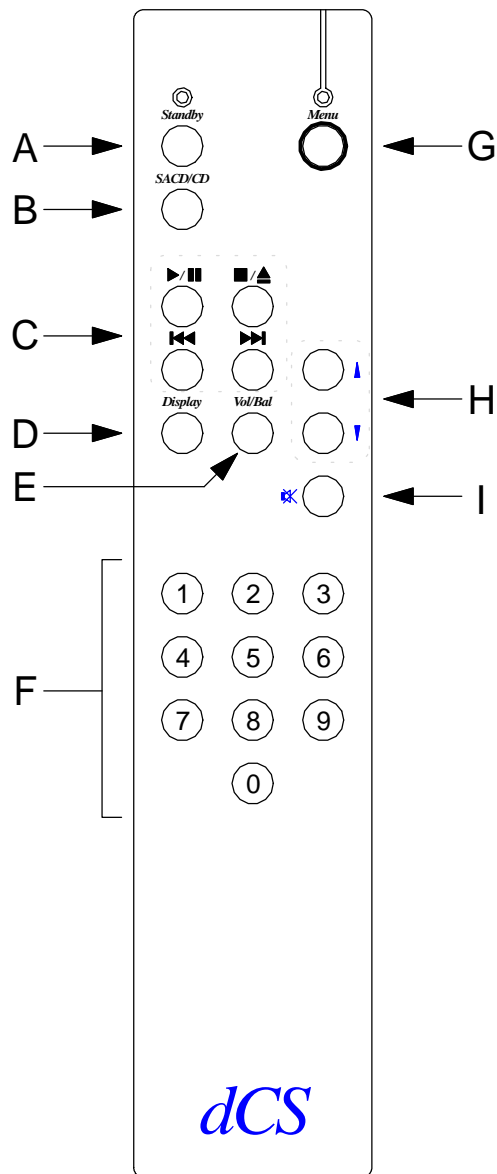

A – Standby button

Pressing the **Standby** button normally sets the *P8i* to standby mode. Press again to restore normal operation.

B – SACD / CD button

IMPORTANT!

The SACD/CD feature is not active in this software release. The SACD layer of hybrid discs will be played.

C – Player Controls

The **Play / Pause**, **Stop / Eject**, **Previous Track** and **Next Track** buttons control the player in the same way as the buttons on the front panel.

The **Previous Track** and **Next Track** buttons also double as **Fast Forward** and **Fast Reverse** buttons on the remote control.

D – Display Button

In SACD mode, pressing this button displays the track number being played for approximately 5 seconds and then reverts back to Track time. This button is used when playing an SACD as the elapsed time is displayed but not the track number. When a red-book CD is played the track number and the elapsed time are displayed simultaneously and therefore this button is not used.

E – Vol/Bal Button

Switches between **Volume** mode and **Balance** mode.

F– 0 – 9 Buttons

The ten numbered buttons are used to select track numbers. We recommend using the numeric keypad for selecting tracks. E.g. If track 5 on a disc is being played but you want to go back to track 3, just press 3 on the remote control keypad.

G – Menu Button

Opens the menu. Use the **↑** and **↓** buttons to page through the menu and press **Menu** again to select a function. Note that the menu may time out if there is no activity for 5 seconds.

H – Up and Down Buttons

Use these keys to alter the settings when in volume or balance mode or to scroll up and down the menu when the menu is open.

I – Mute Button

Press this button to mute or un-mute the analogue outputs of the player.

MAINTENANCE AND SUPPORT

Service and Maintenance

dCS audio products are designed not to need regular maintenance, and contain no user serviceable parts apart from the main fuse. If your unit is damaged in any way, please contact your dealer or dCS.

Mains Fuse

There is a mains fuse below the power inlet, accessible from the outside of the unit. If the fuse blows, it may be changed by the user. The current consumption of the unit is very low, so it only blows if power surges occur, or there is a fault in the unit. Usually power surges cause no other damage, but if the fuse blows repeatedly on replacement, some other damage will have been done and the unit must be returned to dCS for repair.

Fuse type: 20 x 5mm 0.5 amp T HRC fuse

IMPORTANT!

If the fuse should fail, it is essential that it is replaced with one of the same type and rating. Failure to do so could result in damage to the unit, risk of fire or electric shock and will invalidate the guarantee.

Replacing a Blown Fuse

Referring to the diagram below, remove the power cable, use a small flat bladed screwdriver to pry up the tab on the fuse carrier (A) and pull it out. Push the blown fuse out of the clip in the carrier (B) and dispose of it. Fit a new fuse in the clip (C) and push the carrier back into the unit so that it clicks home.

Spare fuses are provided with the unit.

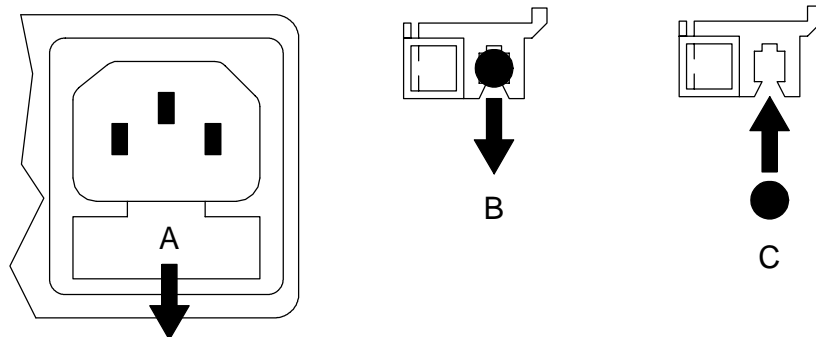

Limited Warranty

General

dCS Ltd. warrants this product against defects in materials and workmanship for a period of 3 years from receipt by the first owner. The warranty on CD mechanisms and related parts is limited to 1 year from receipt by the first owner. During the warranty period, dCS will repair or, at our absolute discretion replace, a faulty product. Warranty repairs must only be carried out by dCS or our authorised service agents. Please contact dCS for details of your nearest service agent.

Your dealer should have completed on your behalf an **Owner Registration** form at the time of sale and returned it to dCS. If you do not receive a **Warranty Certificate** within 30 days of purchase, please contact dCS., stating your name, address, unit serial number and date of purchase.

In the absence of a **Warranty Certificate**, dCS reserve the right to use the original date of shipping from dCS as the start date for the warranty.

This warranty is not transferable.

Warranty Exclusions

The Warranty on this product will be void if:

- the product is misused in any way.
- any unauthorised modifications or repairs are carried out.
- the product is not used in accordance with the Operating Conditions stated in this manual.
- the product is serviced or repaired other than by dCS or our authorised service agents.
- the product is operated without a mains earth (or ground) connection.
- the unit is returned inadequately packed.
- the unit is shipped without the transit screws in place.

This warranty covers parts and labour only, it does not cover shipping charges or tax/duty.

Obtaining Service

Should you encounter a problem, contact your authorised dCS dealer for advice, quoting the model, the full serial number, software version number, and giving a detailed description of the fault. Your dealer will advise you fully on actions that need to be taken. When returning a unit, the original packaging should be used to avoid transit damage. Replacement packaging sets may be purchased from dCS.

During the Warranty period, there will normally be no charge for parts or labour.

Operating Conditions

- The supply voltage must remain within +/-10% of the A.C. voltage specified on the back panel.
- The supply frequency must be in the range 49Hz to 62Hz.
- Ambient temperature range: 0°C (32°F) to 40°C (104°F), non-condensing.
- Do not install the unit near heat sources such as radiators, air ducts, power amplifiers or direct strong sunlight.
- If in doubt, the easy test is – the unit is happy to work anywhere a human is.

If you need more help

In the first instance, you should contact your dealer. If they cannot resolve the issue, contact *dCS*. Our office hours are 8.30 a.m. to 5.00 p.m. Monday to Friday, UK time (GMT in winter or GMT + 1hr in summer). Contact us by phone or fax on:

	Inside the UK	Outside the UK
Telephone	01799 531 999	+44 1799 531 999
Fax	01799 531 681	+44 1799 531 681

You can write to us at:

dCS Ltd
Mull House
Great Chesterford Court
Great Chesterford
Saffron Walden CB10 1PF
UK

Our email address: support@dcsLtd.co.uk

Our web-site is: www.dcsLtd.co.uk

This user guide may be downloaded free of charge from our web-site.

A bound copy of this guide may be ordered from *dCS*.

Software History

dCS products make extensive use of software configurable chips – FPGAs and DSPs. This gives us the ability to update our products to add extra features, update digital interface standards or make performance improvements by loading new software. Occasionally, a hardware update may be necessary also to increase the “capacity” of the electronics, add extra connectors or extra front panel controls.

Please note that not all software updates make an earth-shattering change. You should have a clear idea of what you expect to gain before updating to the latest issue. It is recommended you keep your P8i software up to date. Check the dCS web-site or contact dCS for the latest software updates.

This manual is for P8i software version 1.1x.

Issue 1.10 changes the following:

- Activates the **AES** and **RCA** digital inputs, allowing the unit to be used as a DAC.
- Changes the menu sequence, adding the **Source** page.

Issue 1.05 changes the following:

- Allows the DSD upsampling to be turned off.
- Changes the menu sequence adding the **Upsampling** option.

Issue 1.04 changes the following:

- Activates the **Word Clock Input**.
- Allows the **Digital Outputs** to be turned off.
- Improves the remote handset response.
- Changes the menu sequence adding the **WClk** and **Digital Output** option.

Issue 1.03 changes the following:

- Allows the track number to be displayed briefly by pressing the **Display** button on the remote control.
- Changes the menu sequence.
- Corrects the behaviour when a disc is paused.

Issue 1.02 - Update for internal dCS use.

Issue 1.01 - The first issue.