

***dCS Scarlatti Transport***  
**Upsampling CD / SACD Transport**

**User Manual**  
**Software Release 1.0x**  
**June 2010**

**© Data Conversion Systems Ltd. 2007-2010**

**Price UK £8.00 / Euro 12.00**

All rights reserved. No part of this publication may be reproduced, stored in or introduced into a retrieval system, or transmitted in any form, or by any means (electronic, mechanical, photocopying, recording or otherwise) without the prior written permission of *dCS*<sup>1</sup>. Any person who does any unauthorised act in relation to this publication may be liable to criminal prosecution and civil claims for damages.

Information contained in this manual is subject to change without notice, and whilst it is checked for accuracy, no liabilities can be accepted for errors.

---

<sup>1</sup> *dCS* is Data Conversion Systems Ltd. Company registered in England No. 2072115.



## Contents

<b>Using the dCS Scarlatti Transport for the first time .....</b>	<b>4</b>
What's in the box?	4
Positioning the unit	4
Condensation	4
Safety Notice	5
Laser Radiation	5
Which types of disc can be played?	6
Which types of disc can NOT be played?	6
<b>Step-by-Step Guide .....</b>	<b>7</b>
Preliminaries	7
STEP 1 – Selecting a Digital Output	8
Connecting the IEEE 1394 interface	8
Connecting a Single AES or SPDIF output	8
Connecting the SDIF interface	8
STEP 2 – Choosing a Sync Mode	9
Using the DAC in Master Mode	9
Using a Master Clock	10
STEP 3 – Playing a Disc	11
<b>Front Panel .....</b>	<b>12</b>
CD Tray	12
Display	12
POWER Button	13
STOP / EJECT Button	13
PLAY / PAUSE Button	13
FRV Button	13
FFW Button	13
MENU Button	13
Remote Control Receiver	13
<b>Rear Panel .....</b>	<b>14</b>
AES Digital Outputs	14
SPDIF Digital Outputs	14
SDIF Digital Interface	14
Word Clock Input / Output	14
1394 Interface	14
SUC Connector	14
Mains inlet	14
<b>The Menu .....</b>	<b>15</b>
Using the Menu	16
INFORMATION Menu	17
TRANSPORT SETTINGS Menu	18
DISPLAY SETTINGS Menu	18
SIGNAL GENERATOR Menu	19
<b>Specification .....</b>	<b>20</b>
<b>Maintenance and Support .....</b>	<b>21</b>
Service and Maintenance	21
Replacing a Blown Mains Fuse	21
Cleaning the case	21
Limited Warranty	22
If you need more help	23
Software History	23

---

## USING THE *dCS Scarlatti Transport* FOR THE FIRST TIME

Congratulations on purchasing your *dCS Scarlatti Transport*.

Before using your unit, please read this section and the Step by Step Guide. This will enable you to set the unit up quickly and safely with your hi-fi system.

From time to time, *dCS* will release updated software on CD that you can install yourself using the **CD Update** feature. Please check our web-site occasionally to see if new *Scarlatti* software is available, or consult your dealer.

### What's in the box?

Check that the box contains the following items:

- *dCS Scarlatti Transport*
- Manual and Menu / Setup Guide
- Power cable
- 1394 cable
- BNC cable
- 2 spare fuses
- Pronto Remote Control Handset, Battery Charger and Manual

Notify your dealer as soon as possible if anything is missing or damaged. We suggest that you retain the original packaging for possible future use. If this is not possible, replacement packaging can be ordered from *dCS* or our distributors. Details can be found on our web site at [www.dcsLtd.co.uk](http://www.dcsLtd.co.uk).

### Positioning the unit

Units in the *Scarlatti* range are designed to be mounted on separate shelves of a rack and must NOT be stacked directly on top of each other. Place each unit on a firm, vibration free base, allowing convenient connection to the other parts of your system. To prevent overheating, we recommend that you leave some free space around the unit to allow for ventilation.

### Condensation

If the *Transport* is cold and is moved into a warm room, condensation will form inside the unit. This interferes with normal operation. Remove the *Transport* from its packaging and let it stand for 1-2 hours, to allow it to reach room temperature and the condensation to evaporate.

## Safety Notice



Your *dCS Scarlatti Transport* contains no user serviceable parts. **DO NOT** attempt to open the case as there are potentially dangerous voltages present inside. In the event of the unit developing a fault, please contact your dealer in the first instance.

To maintain protection from electric shock, the unit **MUST** be connected to mains earth (ground) via the power cable. Also, unearthed systems do not give the best sonic performance.



This product is lead-free to comply with the RoHS directive.

Before connecting the power cable to the unit for the first time, please check that it has been set to the correct operating voltage for your mains supply. The unit's voltage setting is shown on the serial number label. If this does not match your local supply voltage, **DO NOT** attempt to use the unit. Contact your dealer to have the unit reset. Using the unit with the wrong mains setting for your local supply may result in serious damage to the unit and will invalidate the warranty. Do not attempt to reset the voltage yourself.

We do not recommend the use of mains regenerators. However, if you do wish to use a mains regenerator with variable voltage and frequency, we recommend that you set the voltage to match your local voltage and the frequency to either 50Hz or 60Hz **ONLY**.



Damage caused to your *Scarlatti Transport* by misuse of a mains regenerator or by a malfunctioning mains regenerator is not covered by the warranty.



Disposal at end-of-life - the symbol indicates that this product should not be treated as normal household waste. It should be recycled, so please take it to an approved collection facility.

## Laser Radiation



*dCS Scarlatti Transport* is a Class 1 Laser Product, it complies with U.S. FDA 21CFR subchapter J. In normal use, there is no risk of exposure to laser radiation.



The case should only be opened by authorised service personnel. The case protects the user from indirect exposure to visible and invisible laser radiation, as well as risk of electric shock.

## Which types of disc can be played?



Commercially manufactured CDs can be played if they:

- are 12cm or 8cm round discs
- are recorded with linear PCM digital audio data
- carry the Compact Disc Digital Audio logo and meet the “Red-Book” standard.



Commercially manufactured single-layer SACDs or hybrid SACD/CD discs can be played if they:

- are 12cm or 8cm round discs
- are recorded with DSD digital audio data on the SACD layer
- carry the Super Audio CD logo and so meet the “Scarlet-Book” standard.

**CD-R** CD-R or CD-RW discs recorded with audio data in CD format may be playable, but this depends on the disc, the software and the burner used to record on the disc.

**CD-RW** dCS Ltd. cannot accept responsibility for any difficulty encountered while attempting to play such discs.

## Which types of disc can NOT be played?

dCS Ltd. cannot accept responsibility for any difficulty encountered while attempting to play the following types of disc:

- Scratched, damaged or dirty discs.
- Printed or labelled CD-Rs or discs contaminated with glue or other sticky substances. These may get stuck inside the unit. If this happens, the warranty on the Transport will be void. A service charge will be made for removing such discs.
- DVD, CD-G, CD-EXTRA, PHOTO CD, CD-ROM or DVD-ROM.
- Copy-protected discs that do not conform to the “Red-Book” CD standard may not play correctly or may not play at all. Such discs are not CDs – they are optical discs that have been recorded with digital audio data. They should not carry the Compact Disc Digital Audio logo – but some do. If you encounter any difficulty playing such discs, please contact the disc manufacturer and demand a **genuine CD** in exchange.

---

## STEP-BY-STEP GUIDE

This section guides you through setting up the unit for basic operation.

### Preliminaries

The Menu / Setup Guide sheet details the menu structure and details the two most common set-ups.

For digital interfaces, use with cables designed for digital audio:

- for AES/EBU interfaces use 110Ω screened, twisted pair cables fitted with one male XLR connector and one female XLR connector.
- for SDIF, Word Clock or SPDIF BNC interfaces, use 75Ω coax cables fitted with BNC plugs.
- for SPDIF RCA interfaces, use 75Ω coax cables fitted with RCA Phono plugs.
- for TOSLINK optical interfaces, use Toslink fibre-optic cables.
- for IEEE 1394 interfaces, use the IEEE 1394 cable provided with the unit.

Switch on the rest of the system first.

Connect the power cable supplied to the power inlet on the Transport rear panel, plug the other end into a convenient power outlet.



Please do not use an excessively heavy or inflexible power cable as this may damage the power inlet connector.

Press the **Power** button and wait about 30 seconds while the Transport configures itself. The display will show in sequence: **Scarlatti** and **No Disc**.

If the unit is likely to be set in an unfamiliar state, you can reset it as follows:

Press the **Menu** button, press the → button once, then the **Menu** button again to display the **Transport Settings** menu. Press the ← button repeatedly to highlight the **Factory Reset** menu page. Press the **Menu** button and wait a few seconds while the unit resets itself.

## STEP 1 – Selecting a Digital Output

Whether you are playing a CD or an SACD, the 1394 interface carries DSD data and all of the PCM outputs carry CD-format data. Most owners connect the 1394 interface only, but some prefer to listen to CDs in the native 16 bit 44.1kS/s format.

### Connecting the IEEE 1394 interface

- Connect **one 1394** output on the *Transport* to **one 1394** input on the *DAC*. Also connect the **Wordclock Out** on the *Transport* to the **Wordclock In** connector on the *DAC*.
- Press the *DAC Input* button repeatedly until **1394** or **dCS STT** is displayed.

The *DAC* may display **Wait ...**, **No-WCik** or **Search...**, messages if the unit is still settling, then in sequence (**Clk OK**), **Locking**, **DSD**. If you have more than one source connected to the 1394 bus, it may be necessary to use the **Input** button to select the 1394 source you want to listen to.

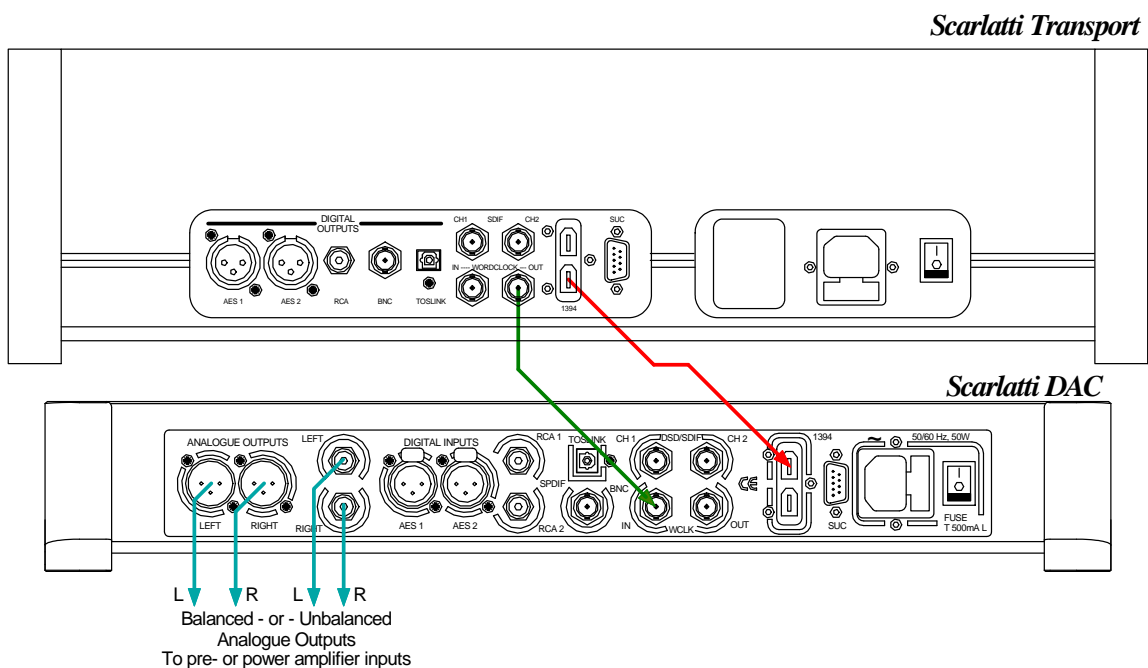

Figure 1 – Basic setup

### Connecting a Single AES or SPDIF output

- Connect one of the outputs on the *Transport* to the matching input on the *DAC* using a suitable cable.
- Press the *DAC Input* button repeatedly until your chosen input is displayed. This will be either **AES1**, **AES2**, **RCA1**, **RCA2**, **Toslink** or **BNC**.

The *DAC* will lock to the source, displaying in sequence (**44.1k**), **Locking**, **16/44.1**.

### Connecting the SDIF interface

- Connect the **CH1** output on the *Transport* to the **CH1** input on the *DAC* and the **CH2** output to the **CH2** input, using two BNC cables. Connect the *Transport's* **Word Clock Out** to the **WCik In** connector on the *DAC*. Ensure the cables are not swapped.
- Press the *DAC Input* button repeatedly until **SDIF** appears on the display.

The *DAC* will lock to the *Transport*, displaying in (**44.1k**), **Locking**, **16/44.1**.

Proceed to Step 2.

## STEP 2 – Choosing a Sync Mode

So far, the system has been set up to lock to the clock generated by the source. If you are using the 1394 or SDIF interfaces, the DAC will lock to a word clock generated by the Transport. This is the simplest arrangement, but it does not give the best sonic performance due to clock jitter.

### Using the DAC in Master Mode

If you have a *Scarlatti Clock*, go to the next page. You can reduce the jitter in your system by using the *Scarlatti DAC* in Master mode and slaving the *Transport* to it.

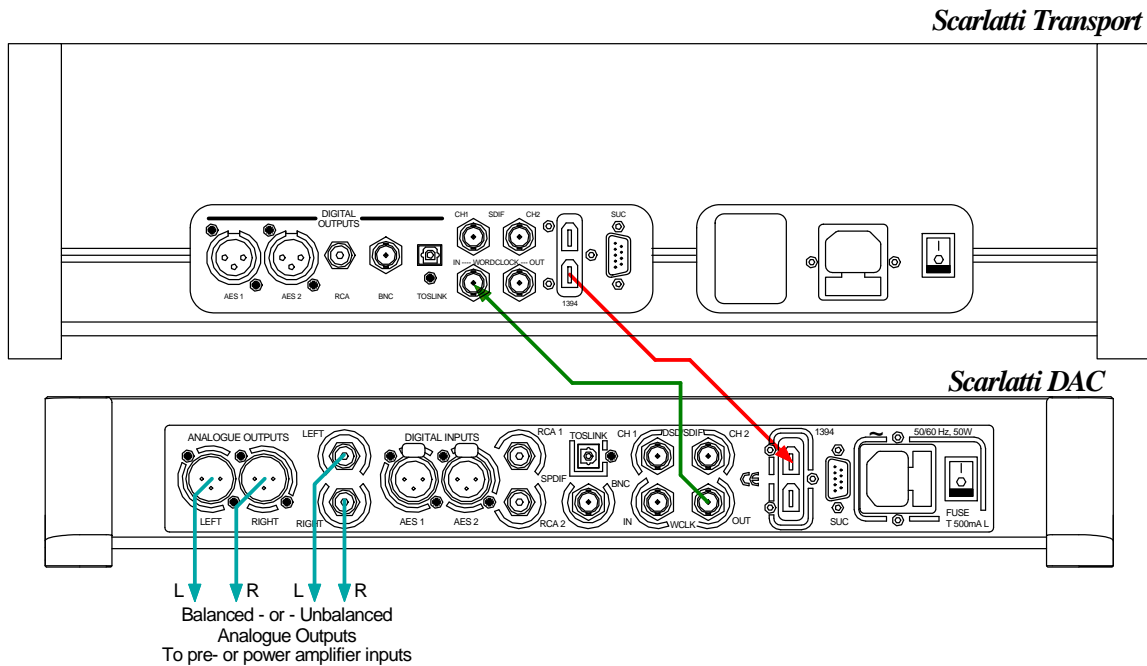

Figure 2 – Using the *Scarlatti* Transport with the DAC in Master Mode

- Use the *DAC*'s **Input** button to select the input you want to use.
- Connect the *DAC*'s **Word Clock Out** connector to the *Transport*'s **Word Clock In** connector. The Transport will lock to the clock and display **Sync**.
- Use the *DAC*'s **Sync** button to set the *DAC* to **Master** mode (see the Master icon below) and allow the system to re-lock.



### Using a Master Clock

The performance can be improved further by adding a *Scarlatti* Clock to the system as shown below.

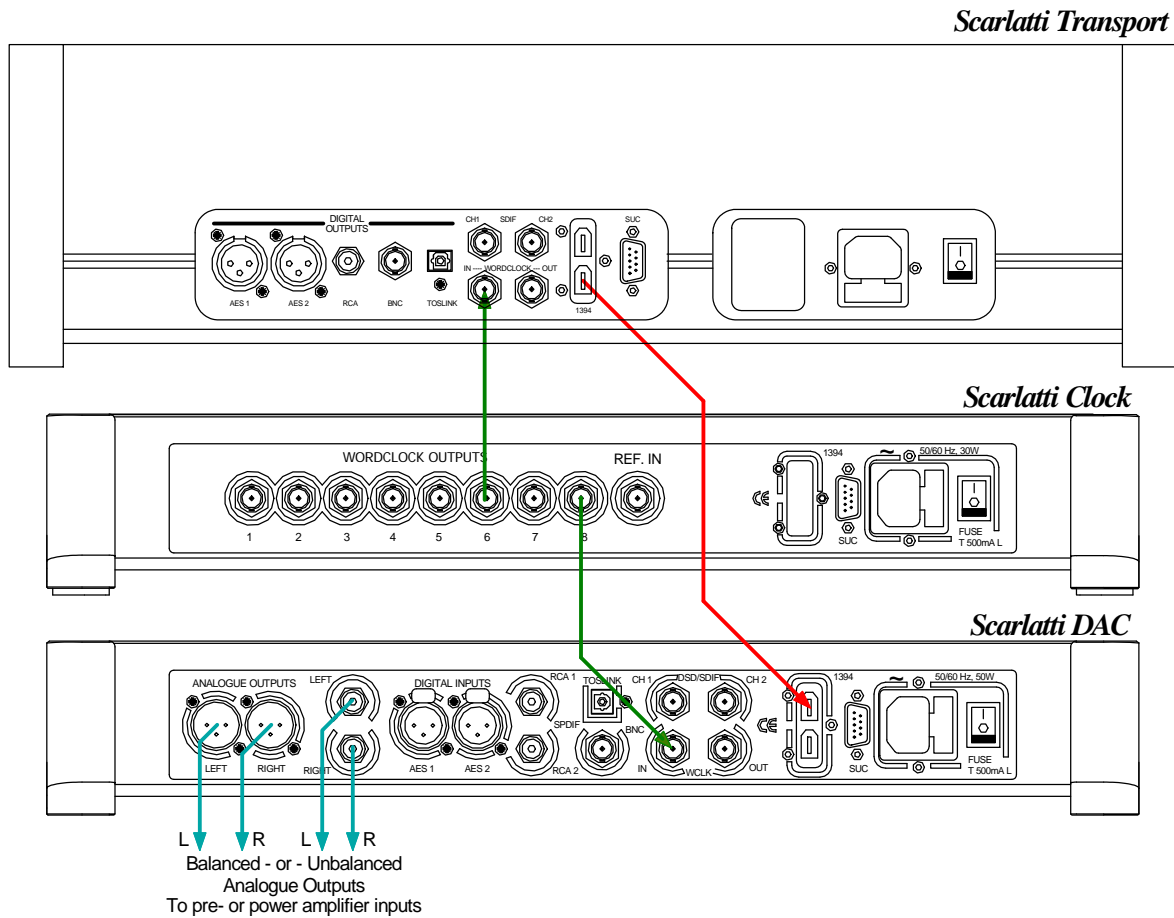
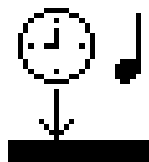

Figure 3 – Using the *Scarlatti* Transport , DAC and Clock together

- Use the *DAC's* **Input** button to select the input you want to use.
- Connect one of the *Clock's* **Word Clock Outputs** to the **Word Clock Inputs** of the *Transport* and *DAC*.
- Use the *Clock's* **Frequency** button to set the outputs to **44.1kHz**, to suit the *Transport*. The *Transport* will lock to the clock and display **Sync**.
- Use the *DAC's* **Sync** button to set the *DAC* to **WCik** mode (see the Word Clock icon below) and allow the system to re-lock.



Please consult the Clock manual for more information on using a Master Clock.

**Proceed to Step 3.**

### STEP 3 – Playing a Disc

- Press the **Stop/Eject** button.

The display will show **OPEN**.

- Load a CD or SACD into the tray with the label upwards and either push the tray in gently or press the **Stop/Eject** button again.

The display will show **CLOSE**, then **LOADING**. The disc type will be identified, either **CD** or **SACD** appear on the display, along with the number of tracks and the total playing time. The Transport will play the SACD layer of a hybrid disc by default, but you can select the CD layer instead using the Remote or the menu.

- Press the **Play** button. Turn up the Volume to a comfortable level.

You should have audio. For all discs, the disc type and elapsed time will be displayed.

- Press the **Play/Pause** button to pause playing, press again to resume playing.
- Press the **FFW** or **FRV** button to skip to the next track or the previous track.
- Hold down the **FFW** or **FRV** button to run through the track at double speed. To go faster, use the **<<** or **>>** buttons on the Remote to select 2x, 4x or 8x speed (see the Pronto Remote manual for details).
- Press the **Stop/Eject** button to stop the disc. Press it again to open the tray.

The Pronto Remote Control gives access to other features, such as track number selection, repeat track or disc and programming a track sequence.

The next step is crucial – sit back and enjoy the music.

When you have finished listening, you can either keep the system warm by setting it to Sleep mode (press the **Power** button briefly) or switch off (hold down the **Power** button until **POWER OFF** is displayed, then release).

## FRONT PANEL

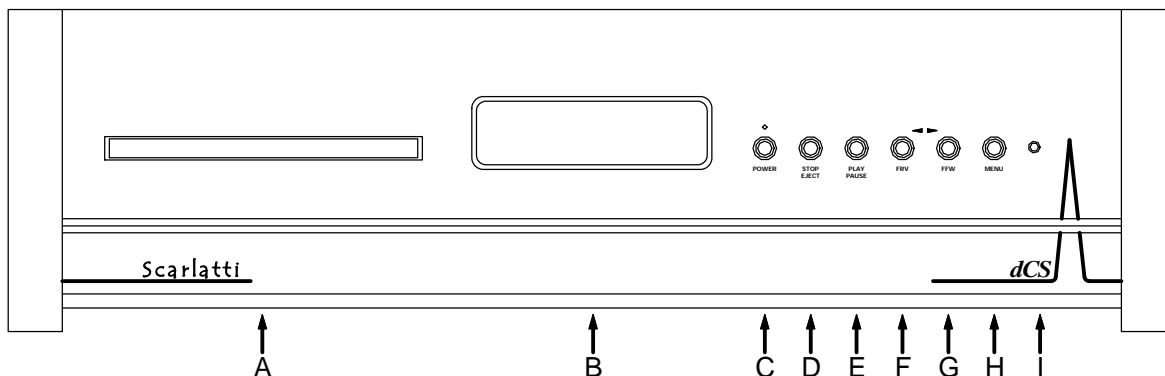

Figure 4 – Front panel

### CD Tray

When loading a CD or SACD into the CD tray (A), ensure the disc is central with the label upwards and is seated correctly.

### Display

In normal use, the display (B) is split into 5 areas:

When stopped, the number of tracks on the disc is shown. When playing or paused, the current track number is shown.

Track or disc time  
(hours, minutes, seconds)

Total elapsed time or  
Total remaining time or  
Track elapsed time or  
Track remaining time

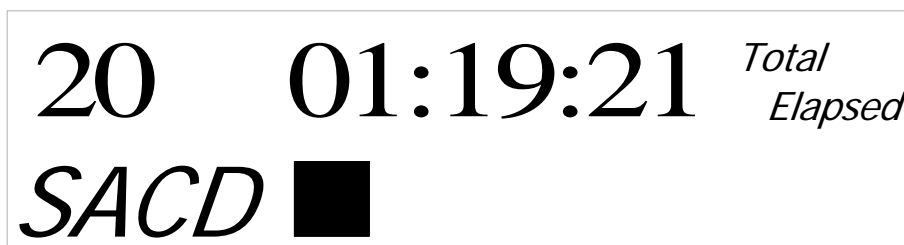

The type of disc or hybrid disc layer: SACD or CD

This symbol indicates the mechanism status: Stop, Play, Pause, Fast Forward, etc.

**Sync** is displayed when the Transport is locked to an external Word Clock. **Sync** appears greyed out while locking is in progress or if the clock cannot be recognised.

**PGM** is displayed when a track sequence is programmed.

Details of the menu displays are shown in the Menu section on page 15.

### **POWER Button**

To switch on, ensure the rear panel switch is set to **I** and press the **POWER** button (C) on the front panel once. Note that the unit cannot be turned on from the remote control.

To set the unit to sleep mode, press the **POWER** button once. The main display will turn off, the LED over the button will illuminate and the mechanism will stop, but the unit will remain close to running temperature. Press again to return to normal operation.

To switch off, hold down the **POWER** button for about 5 seconds until **POWER OFF** appears on the display, then release it. If the tray is open, it will close automatically.

When the menu is open, press the **POWER** button to close the menu.

### **STOP / EJECT Button**

Press the **STOP / EJECT** button (D) to stop playing a disc. Press again to open the CD tray. Press again to close the CD tray.

### **PLAY / PAUSE Button**

After a disc has been read, press the **PLAY / PAUSE** button (E) to start playing. Press again to pause and again to resume playing.

### **FRV Button**

When a disc is playing, press the **Fast ReVerse** button (F) to select the previous track or press and hold to jog back through the current track. (The Remote Control allows you to jog faster.)

When the menu is open, the **Fast ReVerse** button changes to the ← button, used to page backwards through the menu.

### **FFW Button**

When a disc is playing, press the **Fast ForWard** button (G) to select the next track or press and hold to jog forward through the current track. (The Remote Control allows you to jog faster.).

When the menu is open, the **Fast ForWard** button changes to the → button, used to page forwards through the menu.

### **MENU Button**

Press the **MENU** button (H) to open the menu, select menu pages and change settings. See the Menu section on page **15** for information on using the menu features.

### **Remote Control Receiver**

Aim the remote control handset towards the receiver (I) for best sensitivity.

## REAR PANEL

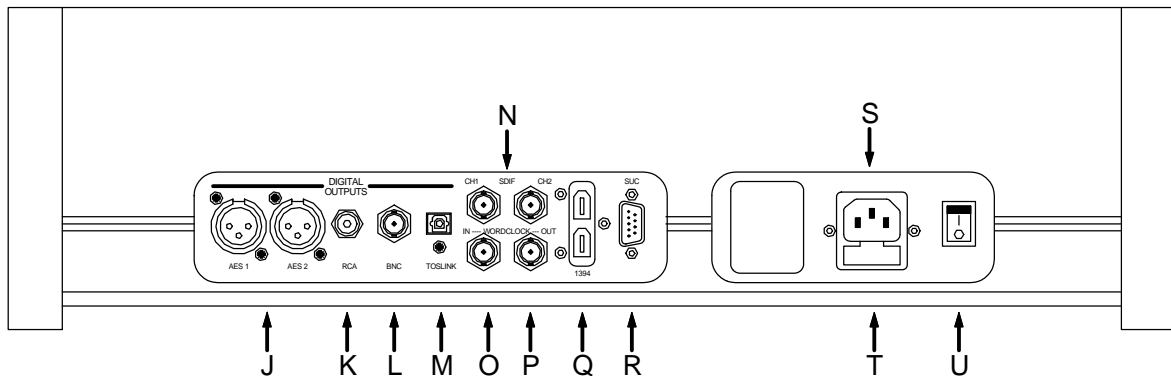

Figure 5 – Rear panel

### AES Digital Outputs

The **AES1** and **AES2** outputs (J) are identical and output CD format data (16 bits at 44.1kS/s), whether a CD or SACD is playing. They do NOT act as a Dual AES pair.

### SPDIF Digital Outputs

The unit features 3 co-ax SPDIF outputs, labelled **RCA** (K) and **BNC** (L), as well as an optical SPDIF output on a **Toslink** connector (M). Pull out the dust cover before using the **Toslink** input. All of them output CD format, whether a CD or SACD is playing.

### SDIF Digital Interface

The **SDIF** interface outputs CD format data, whether a CD or SACD is playing. The interface consists of two data inputs labelled **CH1** and **CH2** (N).

### Word Clock Input / Output

The **WCLK In** connector (O) will accept standard 44.1kHz word clock from a master clock or a DAC in master mode. Once the unit has locked to the clock, **Sync** appears on the display.

The **WCLK Out** connector (P) carries a 44.1kHz word clock.

Word clock is used for synchronisation only, it does not carry digital data.

### 1394 Interface

The IEEE 1394 interface (Q) outputs encrypted DSD data. 1394 interfaces are great for carrying lots of digital data - but are very poor at transmitting a stable clock, so a separate Word Clock connection is required. The two 1394 ports are identical – they can be used as data outputs or as a loop-through. Note that the 1394 bus must not be connected in a loop as this will prevent the system initialising.

### SUC Connector

The **SUC** connector (R) is an RS232 interface, primarily used to remotely control the unit during automated testing. Please contact *dCS* for advice on using this interface with a household automation system. Note that we recommend using infra-red remote control instead.

### Mains inlet

Power is connected via a standard IEC320 connector (S), protected by a fuse (T) and isolated by a 2-pole power switch (U).

# THE MENU

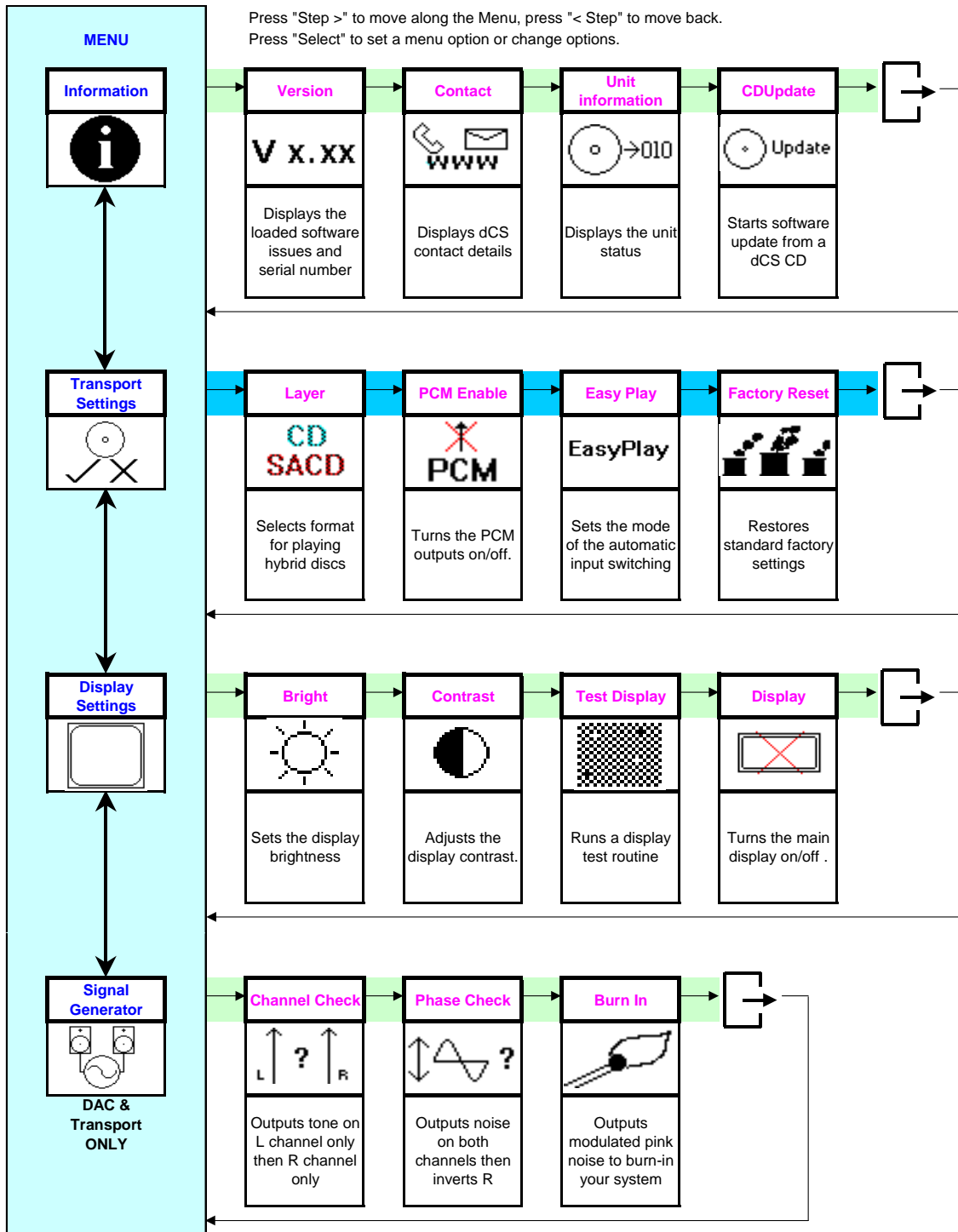

Figure 6 – The menu sequence

## Using the Menu

The menu gives the user access to a range of additional features. It also allows new features and performance enhancements to be added at a later date by software upgrades.

The menu is controlled by four buttons.

- Press the **MENU** button to open the menu or select a setting.
- Press the **→** button to page forward through the menu.
- Press the **←** button pages backward through the menu.
- Press the **POWER** button to close the menu or just wait 5 seconds.

Alternatively, use the remote control to access the menu.

Use the Menu Guide sheet to help you find the right menu.

Each unit in the range has either three or four top-level menu pages:



The **INFORMATION** menu gives software issues, serial number, contact details and unit set-up details.



Each model has a different **SETTINGS** menu, which allows you to set some features that are not directly accessible from the front panel.

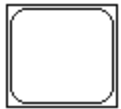

The **DISPLAY SETTINGS** menu is used to adjust and test the display.

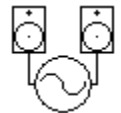

The **SIGNAL GENERATOR** menu (on the Transport and DAC only) contains test and set-up routines.

Use the **→** button to move the highlight to the menu you want, then press the **MENU** button to select it. The next menu level down is displayed. Use the **→** button to move the highlight to the menu page you want, then press the **MENU** button to display the information or change the setting.

Select the exit icon  to go back to the previous menu level.

## INFORMATION Menu

**V X.XX** The **Version** page displays the software versions loaded in the unit and the full serial number. Please have this information ready if you contact your dealer for any reason.



The **Contact** page displays *dCS* web-site URL, email address, telephone and fax numbers. If you have any difficulty, please contact your dealer for help first.

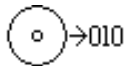

The **Transport Information** page displays the unit status:

- Area: No disc / CD / SACD
- Sled: OK
- Clamp: OK
- Tray: OK
- PCM outputs: on / off
- Mech Version: 0x.xx

Use the ← → buttons to scroll down the list and press the **MENU** button to exit.



The **CD Update** feature allows you to load new software into your system. Please follow the instructions supplied with the update CD carefully.



If you accidentally start a CD Update, switch off the unit at the back panel switch, wait 10 seconds, then switch on again. The software will not have been changed.

## TRANSPORT SETTINGS Menu



When playing a hybrid disc, the **Layer** page allows you to select either the **CD** or **SACD** layer. The active layer will be shown as dark, the other layer will be greyed out. While changing layers and re-reading the disc, **Please wait...** is displayed.



The **PCM Enable** page turns the PCM outputs (**AES**, **RCA**, **BNC**, **Toslink** & **SDIF**) off and on. The **X** shows the outputs are turned off. This gives a quieter electrical environment when you are using the **1394** interface only. Remember to turn the PCM outputs on again if you want to use them!



The **EasyPlay** system automatically selects the right DAC input to suit the type of disc being played. The **EasyPlay** system requires that the DAC is locked to a source when the disc is loaded and a direct 1394 connection between Transport & DAC. The Transport examines the interconnections between units then stores a setup for CD and a setup for SACD. There are 3 options:

- **EasyPlay Off** disables the automatic switching. You will need to set the DAC input to match the type of disc being played.
- **EasyPlay Full** sets the DAC to the **1394#0** input (Transport channel), whether a CD or SACD is played.
- **EasyPlay SACD** sets the DAC to the **1394#0** input when an SACD is played. When a CD is played, the system sets the DAC to the input that is sourced from the Transport, either directly or via an Upsampler. If there is more than one route between the 2 units (ignoring the direct **1394#0** connection) the input is selected in this order of priority: **1394#1** (Upsampler channel), **Dual AES** (via Upsampler), **AES1**, **AES2**, **RCA1**, **RCA2**, **TosLink**, **BNC** and **SDIF**. (Selection of the Upsampler's 1394 channel requires DAC software issue 1.10 or later).



The **Factory Reset** menu page resets the unit to standard settings. These are:

- **Layer** to **SACD**.
- **PCM Enable** to **On**
- **EasyPlay** to **Full**.
- **Display** to **On**.
- **Brightness** to maximum.
- **Contrast** to 60%.

## DISPLAY SETTINGS Menu

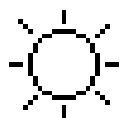

Set the display **Brightness** to a comfortable level.



Set the display **Contrast** to a comfortable level.

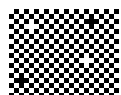

Runs a **Display Test** routine, which flashes all the indicators and the main display.

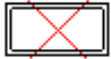

Turns the main display on and off.

## SIGNAL GENERATOR Menu

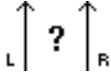

Runs a **Channel Check** routine to test the system for swapped channels. A tone is output on the left channel only while the display shows **Left**, then the right channel only while the display shows **Right**. If these are the wrong way around, the left and right channels are swapped somewhere in your system.



Runs a **Phase Check** routine to test the system for phase reversals. Noise is output in phase on both channels while the display shows **In Phase**. Press the **MENU** button, the noise on the right channel is inverted while the display shows **Out of Phase**. The first burst should produce a central image, the second burst should not. If these are the wrong way around, one channel in your system is phase inverted. Press the **←** or **→** button to stop the test and return to the menu.



Runs a **Burn-In** procedure to condition your system. The unit displays **Burn In Caution! Loud**, then outputs modulated pink noise that ramps up slowly in level. Press the **MENU** or **← →** buttons to stop the procedure.



Please ensure that the volume level is reasonable, as careless use of the **Burn-In** routine can damage your amplifiers and loudspeakers. *dCS* will not be liable for such damage.

## SPECIFICATION

<b>Mechanism type</b>	Dual laser CD/SACD mechanism.
<b>Digital outputs</b>	IEEE 1394 interface on 2x 6-way connectors. The interface outputs <i>dCS</i> -encrypted DSD (1 bit data at 2.822MS/s).
	2x AES/EBU on 3-pin male XLR connectors. Each outputs CD format data (16 bits at 44.1kS/s), whether a CD or SACD is playing.
	2x SPDIF on 1x RCA Phono and 1x BNC connectors. Each outputs CD format data, whether a CD or SACD is playing.
	1x SPDIF optical on a Toslink connector, outputs CD format data, whether a CD or SACD is playing.
	1x SDIF-2 interface on 2x BNC connectors, outputs CD format data, whether a CD or SACD is playing.
<b>Clocking</b>	Word Clock Output on 1x BNC connector. With the transport in Master mode, a TTL-compatible 44.1kHz word clock derived from the internal crystal oscillator is available on this output. The calibration accuracy when shipped is +/-10ppm, not temperature compensated. Calibration usually remains stable for several years, but this is not guaranteed.
	Word Clock Input on 1x BNC connector, accepts standard word clock at 44.1kHz. Sensitive to TTL levels. Lock range is +/-300ppm.
<b>Size and weight</b>	513mm (20.2") long x 424mm (16.7") deep x 140mm (5.5") high. Allow extra depth for cable connectors. Allow space for air flow around the unit.
	19.6kg (43.2lbs).
<b>Power requirements</b>	Internally set to either 100, 115/120, 220 or 230/240V AC, 49 – 62Hz.
	Power consumption: 25W typical, 40W maximum.

These specifications are subject to change without notice.

## MAINTENANCE AND SUPPORT

### Service and Maintenance

dCS audio products are designed not to need regular maintenance, and contain no user serviceable parts apart from the mains fuse. If your unit is damaged in any way, please contact your dealer.

### Replacing a Blown Mains Fuse

There is a mains fuse below the power inlet, accessible from the outside of the unit. If the fuse blows, it may be changed by the user. The current consumption of the unit is very low, so it only blows if power surges occur, or there is a fault in the unit. Usually power surges cause no other damage, but if the fuse blows repeatedly on replacement, some other damage will have been done and the unit must be returned to dCS for repair.

Fuse type: 20 x 5mm T0.5 amp L fuse



If the fuse should fail, it is essential that it is replaced with one of the same type and rating. Failure to do so could result in damage to the unit, risk of fire or electric shock and will invalidate the warranty.

Referring to the diagram below, remove the power cable, use a small flat bladed screwdriver to pry up the tab on the fuse carrier (A) and pull it out. Push the blown fuse out of the clip in the carrier (B) and dispose of it. Fit a new fuse in the clip (C) and push the carrier back into the unit so that it clicks home.

Spare fuses are provided with the unit.

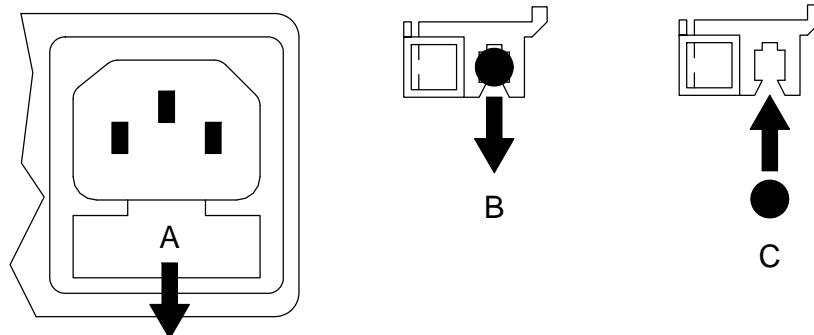

### Cleaning the case

The front and back panels of your dCS equipment are machined from very high grade aluminium. Great care has been taken to create the finish of the aluminium throughout the engineering process from the raw solid material to the finished piece.

To remove loose dust or finger marks from the case, we recommend that you use a clean, dry, lint-free cloth.

To restore the finish on the front and back panels, we recommend applying small quantities of a lanolin based cleaner, using a clean, dry, lint-free cloth and then wiping off. Do not allow lanolin to collect around the buttons.

Small amounts of glass cleaner containing ammonia may be used to clean other surfaces, but avoid spraying onto the connector contacts.

---

## Limited Warranty

### General

dCS warrants this product against defects in materials and workmanship for a period of 3 years from the date the unit was originally shipped from dCS. During the warranty period, dCS will repair or, at our absolute discretion, replace a faulty product. Warranty repairs must only be carried out by dCS or our authorised service agents. Please contact your dealer if your unit requires service.

Your dealer should have completed on your behalf an **Owner Registration** form at the time of sale and returned it to dCS. On receipt of the Owner Registration form, dCS will add your contact details to our customer database. dCS will use this information for warranty purposes only, we will not contact you directly for reasons relating to sales and marketing.

This warranty applies to the original owner.

### Warranty Exclusions

The Warranty does not cover wear and tear.

The Warranty on this product will be void if:

- the product is misused in any way.
- any unauthorised modifications or repairs are carried out.
- the product is not used in accordance with the Operating Conditions stated in this manual.
- the product is serviced or repaired other than by dCS or our authorised service agents.
- the product is operated without a mains earth (or ground) connection.
- the unit is returned inadequately packed.

dCS reserve the right to apply a service charge if a product returned for warranty repair is found to be operating correctly, or if a product is returned without a returns number being issued.

This warranty covers parts and labour only, it does not cover shipping charges or tax/duty.

Our dealers or distributors are NOT authorised to extend the terms of this warranty, dCS cannot accept responsibility for any attempt to do so.

Products re-sold by dCS on a "used" basis may be subject to reduced warranty terms.



The Philips Pronto is covered by a Philips 12-month parts & labour warranty, it is NOT covered by the 3-year warranty which protects the rest of your dCS system. The Philips warranty does not cover damage caused by misuse or accidental damage.

### Obtaining Service

Should you encounter a problem, contact your authorised dCS dealer for advice, quoting the model, the full serial number, software version number, and giving a detailed description of the fault. Your dealer will advise you fully on actions that need to be taken. When returning a unit, the original packaging should be used to avoid transit damage. Replacement packaging sets may be purchased from dCS.

During the Warranty period, there will normally be no charge for parts or labour.

In the event that the Philips Pronto supplied with your dCS system develops a fault within 12 months of registering your purchase with dCS, (or within 12 months of the original date of shipping from dCS) please contact dCS for a returns number and then return it to us. We will arrange for it to be repaired by Philips. A service charge will be made for non-warranty repairs.

## Operating Conditions

- The supply voltage must remain within +/-10% of the A.C. voltage specified on the back panel.
- The supply frequency must be in the range 49Hz to 62Hz.
- Ambient temperature range: 0°C (32°F) to 40°C (104°F), non-condensing.
- Do not install the unit near heat sources such as radiators, air ducts, power amplifiers or direct strong sunlight.
- If in doubt, the easy test is – the unit is happy to work anywhere a human is.

## If you need more help

In the first instance, you should contact your dealer. If they cannot resolve the issue, contact your national distributor.

Manufactured by:

Data Conversion Systems Ltd.  
Unit 1, Buckingway Business Park,  
Anderson Road,  
Swavesey,  
Cambridgeshire. CB24 4AE  
UK

[www.dcsltd.co.uk](http://www.dcsltd.co.uk)

This user manual may be downloaded free of charge from our web-site.

A bound copy of this manual may be ordered from *dCS*.

## Software History

*dCS* products make extensive use of software configurable chips – FPGAs and DSPs. This gives us the ability to update our products to add extra features, update digital interface standards or make performance improvements by loading new software. Occasionally, a hardware upgrade may be necessary also to increase the “capacity” of the electronics, add extra connectors or extra front panel controls.

Please note that not all software updates make an earth-shattering change. You should have a clear idea of what you expect to gain before updating to the latest issue. We recommend that you keep your software up to date. Check the *dCS* web-site for the latest software updates.

This manual is for *Scarlatti Transport* software version 1.0x.

Issue 1.00 - The first issue, with 1394 issue 3.00.