

dCS Paganini Upsampler
Digital to Digital Converter

User Manual
Software Release 1.1x
March 2011

© Data Conversion Systems Ltd. 2009-2011

Price UK £8.00 / Euro 12.00

All rights reserved. No part of this publication may be reproduced, stored in or introduced into a retrieval system, or transmitted in any form, or by any means (electronic, mechanical, photocopying, recording or otherwise) without the prior written permission of *dCS*¹. Any person who does any unauthorised act in relation to this publication may be liable to criminal prosecution and civil claims for damages.

Information contained in this manual is subject to change without notice, and whilst it is checked for accuracy, no liabilities can be accepted for errors.

¹ *dCS* is Data Conversion Systems Ltd. Company registered in England No. 2072115.

Contents

Using the dCS Paganini Upsampler for the first time.....	4
What's in the box?	4
Positioning the unit	4
Safety Notice	5
Patent Pending	5
Step-by-Step Guide	6
Preliminaries	6
STEP 1 - Connecting an Input	7
STEP 2 – Setting up the USB source	8
A word about Music Playing Software	8
Selecting the <i>Paganini Upsampler</i> as your Audio Output device	8
STEP 3 – Connecting an Output	9
Single wire PCM	9
Dual AES	10
1394 interface	11
STEP 4 - Setting the Sync Source	12
Using the USB input in Master Mode	12
Using a Master Clock	12
A Typical 4-box Paganini System	13
Using the Paganini Upsampler and DAC	14
Front Panel.....	15
POWER Button	15
MENU Button	15
INPUT button	15
OUTPUT Button	15
Remote Control Receiver	16
Display	16
Rear Panel	17
Digital Inputs	17
Digital Outputs	17
Word Clock Input / Output	18
SUC Connector	18
Mains inlet	18
The Menu	19
Using the Menu	20
INFORMATION Menu	21
UPSAMPLER SETTINGS Menu	22
DISPLAY SETTINGS Menu	25
Specification	26
Maintenance and Support.....	27
Service and Maintenance	27
Replacing a Blown Mains Fuse	27
Cleaning the case	27
Limited Warranty	28
Operating Conditions	28
If you need more help	29
Software History	29

USING THE *dCS Paganini Upsampler* FOR THE FIRST TIME

Congratulations on purchasing your *dCS Paganini Upsampler*.

Before using your unit, please read this section and the Step by Step Guide. This will enable you to set the unit up quickly and safely with your hi-fi system.

From time to time, *dCS* will release updated software on CD that you can install yourself using the **CD Update** feature. Please check our web-site occasionally to see if new *Paganini* software is available, or consult your dealer.

What's in the box?

Check that the box contains the following items:

- *dCS Paganini Upsampler*
- Manual and Menu / Setup Guide
- Power cable
- 1394 cable
- BNC cable
- USB cable
- 2 spare fuses

Notify your dealer as soon as possible if anything is missing or damaged. We suggest that you retain the original packaging for possible future use. If this is not possible, replacement packaging can be ordered from *dCS* or our distributors. Details can be found on our web site at www.dcsLtd.co.uk.

The cables supplied are commercial-grade parts, as we realise our customers will want to make their own choices.

The *dCS* Premium Remote handset is supplied as standard with the *Paganini Transport*. If you do not have a *Paganini Transport* in your system or it was supplied with the original basic remote handset, a remote control can be ordered direct from *dCS* as an optional extra.

Positioning the unit

Units in the *Paganini* range may be stacked directly on top of each other, but are likely to give better sonic results when mounted on separate shelves of a rack. Place each unit on a firm, vibration free base, allowing convenient connection to the other parts of your system. To prevent overheating, we recommend that you leave some free space around the unit to allow for ventilation.

3 feet are fitted as standard, this may be changed to the 4-foot arrangement shown below, if you prefer. Spare feet are available as an optional extra. The mounting points are M4 size, maximum screw depth is 10mm.

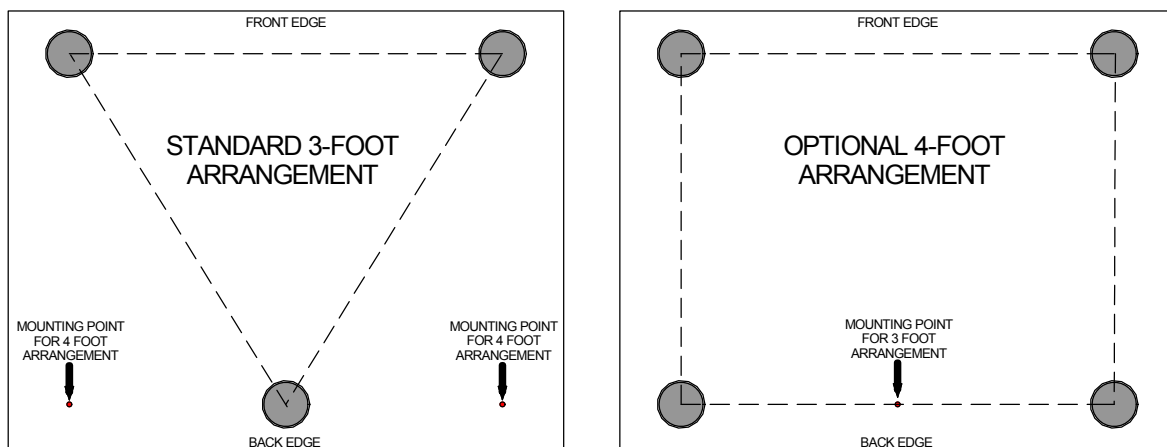

Safety Notice



Your *dCS Paganini Upsampler* contains no user serviceable parts. **DO NOT** attempt to open the case as there are potentially dangerous voltages present inside. In the event of the unit developing a fault, please contact your dealer in the first instance.

To maintain protection from electric shock, the unit **MUST** be connected to mains earth (ground) via the power cable. Also, unearthed systems do not give the best sonic performance.



This product is lead-free to comply with the RoHS directive.

Before connecting the power cable to the unit for the first time, please check that it has been set to the correct operating voltage for your mains supply. The unit's voltage setting is shown on the serial number label. If this does not match your local supply voltage, **DO NOT** attempt to use the unit. Contact your dealer to have the unit reset. Using the unit with the wrong mains setting for your local supply may result in serious damage to the unit and will invalidate the warranty. Do not attempt to reset the voltage yourself.

We do not recommend the use of mains regenerators. However, if you do wish to use a mains regenerator with variable voltage and frequency, we recommend that you set the voltage to match your local voltage and the frequency to either 50Hz or 60Hz **ONLY**.



Damage caused to your *Paganini Upsampler* by misuse of a mains regenerator or by a malfunctioning mains regenerator is not covered by the warranty.



Disposal at end-of-life - the symbol indicates that this product should not be treated as normal household waste. It should be recycled, so please take it to an approved collection facility.

Patent Pending

This product contains novel features that are the subject of patent application GB0817141.5.

STEP-BY-STEP GUIDE

This section guides you through setting up the unit for basic operation.

Preliminaries

The Menu / Setup Guide sheet details the menu structure and details the two most common set-ups.

For digital interfaces, use with cables designed for digital audio:

- for AES/EBU interfaces use 110Ω screened, twisted pair cables fitted with one male XLR connector and one female XLR connector.
- for Word Clock interfaces, use 75Ω coax cables fitted with BNC plugs.
- for SPDIF RCA interfaces, use 75Ω coax cables fitted with RCA Phono plugs.
- for IEEE 1394 interfaces, use the IEEE 1394 cable provided with the unit.
- For USB interfaces, use the USB cable provided with the unit.

Connect the power cable supplied to the power inlet on the Upsampler's rear panel, plug the other end into a convenient power outlet.



Please do not use an excessively heavy or inflexible power cable as this may damage the power inlet connector.

Set the rear panel power switch to the **I** position. Briefly press the **Power** button and wait about 30 seconds while the Upsampler configures itself. The display will show in sequence: **dCS**, **Paganini Upsampler** and **No Input > 24/96**.



If the unit is likely to be set in an unfamiliar state, you can reset it as follows:

Press the **Menu** button, press the **→ (Output)** button once, then the **Menu** button again to display the **Upsampler Settings** menu. Press the **← (Input)** button repeatedly to highlight the **Factory Reset** menu page. Press the **Menu** button and wait a few seconds while the settings are reset.

STEP 1 - Connecting an Input

Use suitable cables to connect your source equipment to the matching digital input connectors on the back panel of the Paganini Upsampler. The unit will accept up to 24-bit data at 32, 44.1, 48, 88.2 or 96kS/s. You can connect any interfaces you need or all 4 if you wish.

Use the **INPUT** button on the front panel to select the input you require, the choices are: **AES**, **USB**, **RCA1** & **RCA2**.

The label for the selected input at the top left corner of the screen will highlight. If the source is generating recognisable PCM, the Upsampler will lock, displaying the input / output sample rates and the **Sync** icon:



For example, when connected to an AES source generating 16/44.1 data:

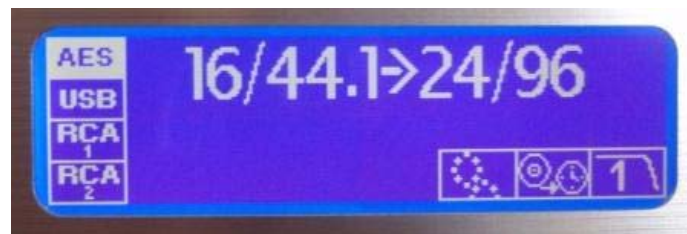

Go to **STEP 2**.

STEP 2 – Setting up the USB source

The USB interface can be connected to a Windows™ Vista/ Windows™ 7 or XP (SP2 or later) PC, Mac™ OSX (10.5.4 or later) systems or a sound server, running software to generate PCM data.

If you do not want to use a USB source, **go to STEP 3.**

A word about Music Playing Software

There are countless programs that can play music on Windows™ PC and Apple Mac™ OSX systems. Unfortunately, not all of them present the data completely unprocessed to the USB ports. For example, Windows Media Player re-samples all data to 24 bits, albeit at the original sample rate, whilst iTunes rate converts data as necessary to the output sample rate set in the OSX Audio set-up panel.

With such a proliferation of playing software, and with updates being issued daily, it is impossible for *dCS* to be fully up-to-date with the behaviour and performance of all programs. If you have questions or problems, we would urge you to take them up with your software vendor. What we will say is that different programs operate very differently and it is well worth finding out exactly how your particular program processes the audio.

One particular problem that has been identified and is worthy of note, concerns the popular iTunes program when running on Windows systems. The default output word length is 16 bits and must be changed to 24 bits for correct operation. To do this, click on **Start > Control Panel > Quicktime**. Click on the **Audio** tab of the Quicktime panel and select **24 bit** in the **Size** field of the **Sound Out** section.

Selecting the *Paganini Upsampler* as your Audio Output device

Whichever program you are using to play your music, your computer may not automatically select your *Paganini Upsampler* as the preferred playback device. You can correct this as follows :

Windows XP - Once you have connected the *Paganini Upsampler* and switched it on, go to **Start > Control Panel > Sounds and Audio devices**. Click on the **Audio** tab and select **dCS Paganini** from the drop down list in the **Sound Playback** Default device list. For best results, set the **Sample Rate** to be the same as that of the file.

Windows Vista - Once you have connected the *Paganini Upsampler* and switched it on, go to **Start > Control Panel > Hardware and Sound > Sound** and click on the **Playback** tab of the panel that appears. **dCS Paganini** will appear in the list of available devices. For best results, set the **Sample Rate** to be the same as that of the file.

Mac™ OSX - Once you have connected the *Paganini Upsampler* and switched it on, open **Finder**, click on the **Go** tab and select **Utilities**. In the Utilities panel, select **Audio MIDI Setup** and click on the **Audio Devices** in the Audio MIDI setup panel. Select **dCS Paganini** from the drop down list in the **System Output**. You can also set **dCS Paganini** as the default output from the same panel. For best results, set the **Sample Rate** to be the same as that of the file.

For more detailed advice, please visit www.dcsLtd.co.uk/page/support and download the "*dCS Guide to Computer Audio*".

Go to STEP 3.

STEP 3 – Connecting an Output

Choose which output interface you want to use and connect it up as described below. You can connect as many outputs as you wish.



If the output format is not compatible with a particular interface, that interface will not be active (for example, the **AES1** output cannot carry DSD). The Upsampler will not output sample rates that are lower than the input sample rate.

Single wire PCM

Connect one or more of the PCM outputs (**AES1**, **AES2**, **RCA1**, **RCA2**) to matching inputs on your DAC. Use the **OUTPUT** button on the front panel to set the output sample rate to 32, 44.1, 48, 88.2 or 96kS/s. Use the DAC's **INPUT** button to select that input.

Paganini Upsampler

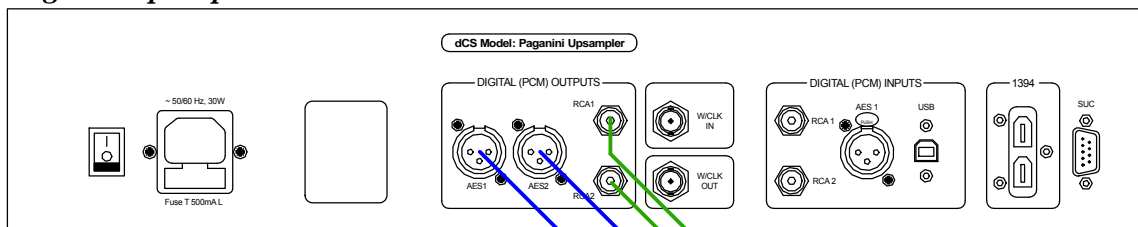

Paganini DAC

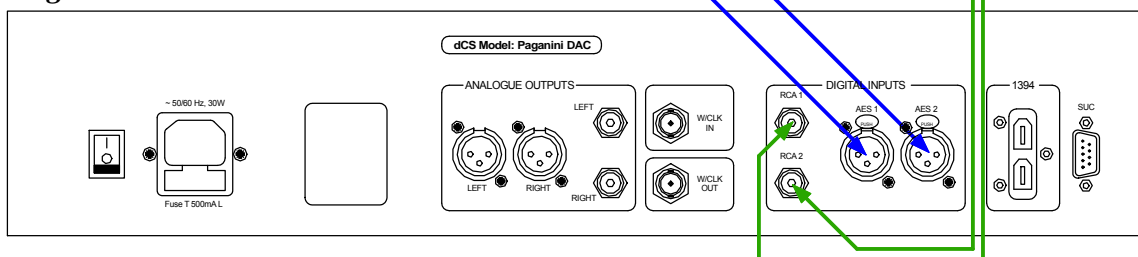

Figure 1 – Connecting the single-wire outputs

Go to **STEP 4**.

Dual AES

Connect the **AES1** and **AES2** outputs to matching inputs on your DAC. Use the **OUTPUT** button on the front panel to set the output sample rate to 88.2, 96, 176.4 or 192kS/s. If you choose 88.2 or 96kS/s, open the menu, scroll to the **Upsampler Settings** page and make sure **Dual AES** is **On**. If it is not, scroll to **Single AES** and press the **MENU** button to change it to **Dual AES**. Use the DAC's **INPUT** button to select the **Dual AES** input. You may need to open the DAC's menu and set it to accept Dual AES.



All *dCS* DACs are capable of Dual AES operation, but some other manufacturer's DACs may have 2 single AES inputs that are not Dual AES capable. Please check the DAC manual to be sure.

Paganini Upsampler

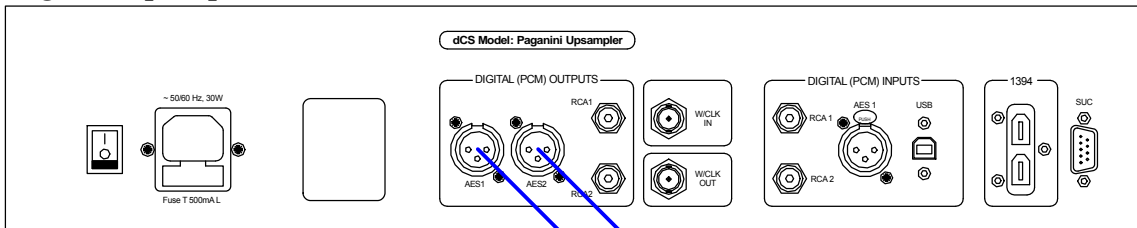

Dual AES

Paganini DAC

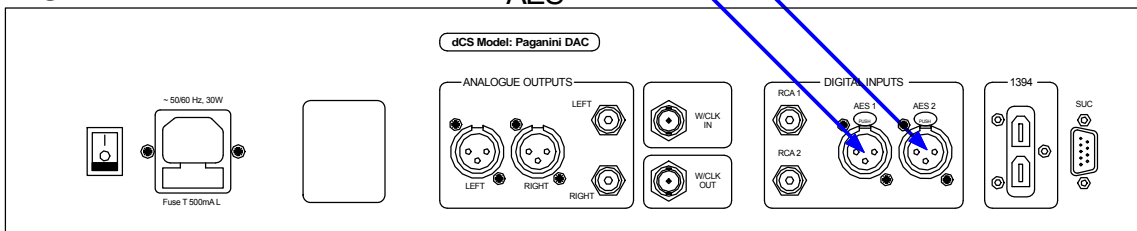

Figure 2 – Connecting the Dual AES output

Go to STEP 4.

1394 interface

Connect the Upsampler's 1394 output to the 1394 interface on a dCS DAC. Use the **OUTPUT** button on the front panel to set the output format to DSD. If the DAC and the Upsampler are not locked to a master clock, also connect the Upsampler's **W/Clock Out** to the DAC's Word Clock Input. Use the DAC's **INPUT** button to select the **1394** input. If necessary, set the DAC to sync to its Word Clock Input. The DAC will lock and display **PUP**.



The Upsampler's 1394 interface is unlikely to work with other manufacturer's 1394 interfaces due to proprietary encryption.



You can connect 1394 cables in a "tree", but do not connect them in a loop as this prevents the system initialising.

Paganini Upsampler

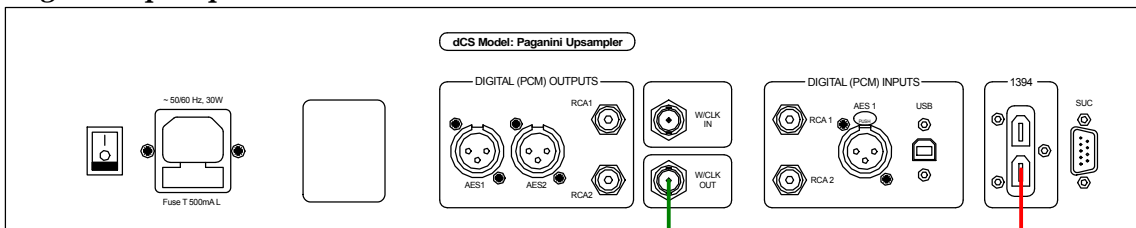

Paganini DAC

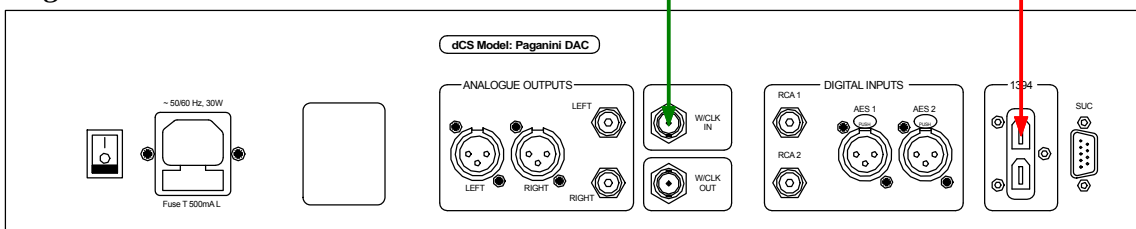

Figure 3 – Connecting the 1394 interface

Go to **STEP 4**.

Start the source playing and set the DAC's Volume control to a comfortable level.

You should have audio at this point.

STEP 4 - Setting the Sync Source

The system has been set up to lock to the clock generated by the source, (unless you are using the **USB** input) and the **Sync** icon should be displayed. To check this, press the **Menu** button, press the **→** button once, then the **Menu** button again to display the **Upsampler Settings** menu. If the Upsampler was reset at the start of this procedure, you should see the **Sync Source – Audio** icon:



This is the simplest arrangement, but it does not give the best sonic performance due to clock jitter. You can improve the performance by adding a Master Clock to your system.

Using the USB input in Master Mode

Jitter from computer sources is typically very severe and can degrade the audio quality. To avoid this, the Upsampler's USB interface runs in Asynchronous mode. The Upsampler does not lock to the source clock, but uses the Upsampler's internal clock instead - this is called Master Mode - and adjusts the source to the same clock frequency. To use the Master Mode:

- Connect the Upsampler's **USB** interface to a suitable source.
- Use the Upsampler's **INPUT** button to select the **USB** interface.
- Press the **Menu** button, press the **→** button once, press the **Menu** button to display the **Upsampler Settings** menu, press the **→** button to select the **Sync Source** page and then press the **Menu** button as necessary to change the setting to **Master**:



- Set the Upsampler's **OUTPUT** rate as you wish, connect the appropriate outputs to the DAC and use the DAC's **INPUT** button to select that input.

The Upsampler will draw data from the source, but it is not locked to the source, so the **Sync** icon is NOT displayed. You can improve the performance by adding a Master Clock to your system.

Using a Master Clock

If you have a *Paganini Clock* (or other dedicated Clock) in your system, lock the source, the Upsampler and the DAC to the Clock for the best performance. To do this:

- Connect the Clock's **Word Clock Outputs** to the **Word Clock Inputs** on the source, Upsampler and DAC.
- Set the Clock **Frequency** to suit the source and DAC. For a CD Transport as source with the Upsampler set to output **24/176.4** or **DSD**, the correct frequency is **44.1kHz**. For a 24/48 source with the Upsampler set to **24/192**, the correct frequency is **48kHz**.
- Select the required input on the Upsampler and DAC. This is important because these units store a different **Sync Source** setting for each input.
- To set the Upsampler to lock to the Clock, press the **Menu** button, press the **→** button once, press the **Menu** button to display the **Upsampler Settings** menu, press the **→** button to select the **Sync Source** page and then press the **Menu** button as necessary to change the setting to **WCik**:



- The *Paganini Upsampler* will display the **Sync** icon, provided the clock is recognised. If there is no signal at the **Word Clock In** connector or it is not recognisable, the Upsampler will sync to audio and display this icon to warn you:



- The *Paganini Transport* will automatically lock to the Clock and display **Sync**.
- Set the *Paganini DAC* to sync to Word Clock by pressing the **SYNC** button as necessary.

Using the Paganini Upsampler and DAC

If your system consists of a computer, *Paganini Upsampler* and *DAC* but you do not have a *Clock*, you can use the DAC as the Master Clock as described below.

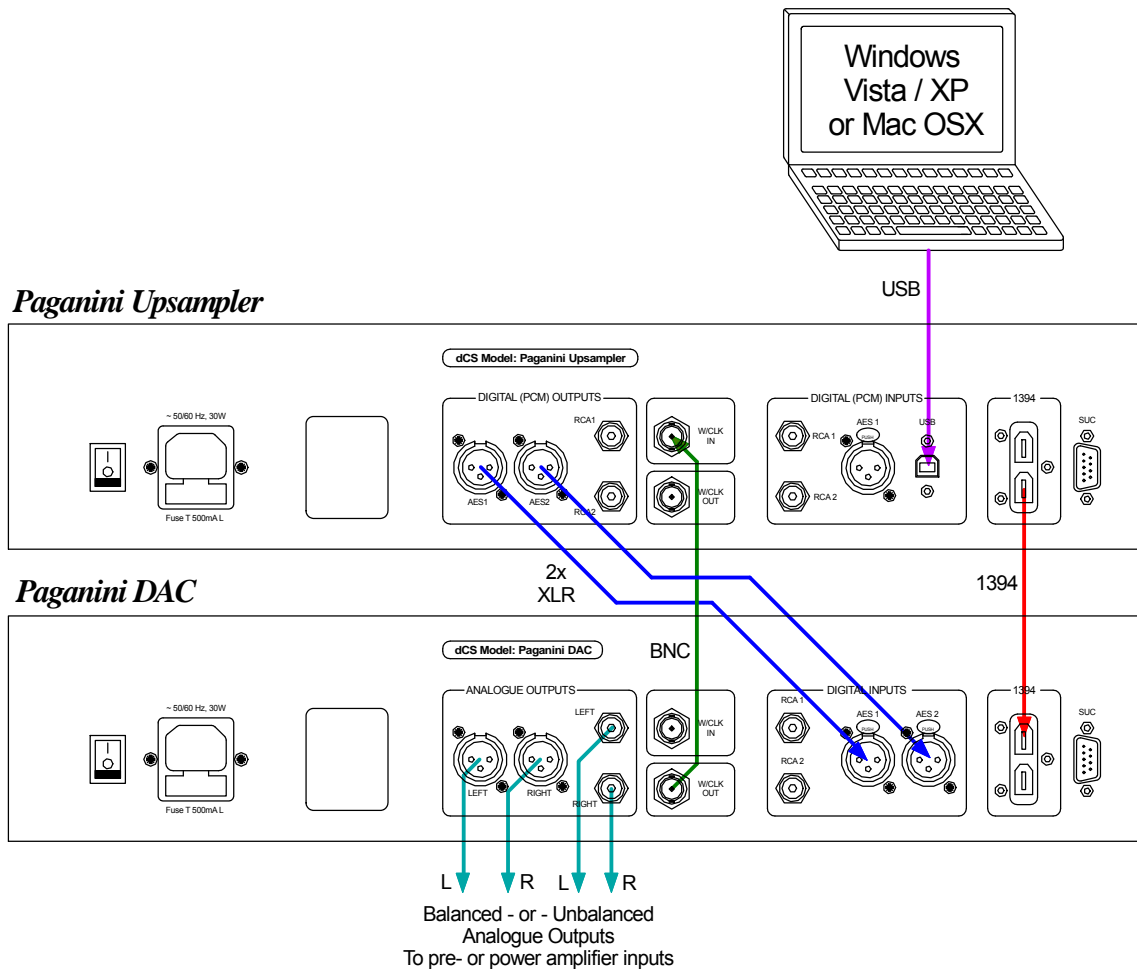

Figure 5 – Using a *Paganini* Upsampler and DAC with a laptop

- The system is synchronised by the DAC running in Master Mode at **44.1kHz**. Remember to select the DAC input first before using the DAC's **Sync** button to select **Master**.



The DAC will NOT operate in Master mode when receiving 32, 48, 96 or 192kS/s data.

- The Upsampler takes data from the laptop, it will typically be set to upsample to **24/176.4** or **DSD**. Set the **Upsampler Settings / Sync Source** menu page to **WClk**.
- The DAC takes data from the Upsampler via **1394** (DSD) or **Dual AES** (24/176.4), it is your choice.

For further improvement, add a *Paganini Clock* to the system.

The next step is crucial – sit back and enjoy the music.

FRONT PANEL



Figure 6 – Front panel

POWER Button

To switch on, ensure the rear panel switch is set to **I** and press the **POWER** button (A) on the front panel once. Note that the unit cannot be turned on from the remote control.

To set the unit to sleep mode, press the **POWER** button once. The main display will turn off, the LED to the left of the button will illuminate, and the outputs will mute, but the unit will remain close to running temperature. Press again to return to normal operation.

To switch off, hold down the **POWER** button for about 5 seconds until **Power Down** appears on the display, then release it.

When the menu is open, press the **POWER** button to close the menu.

MENU Button

Press the **MENU** button (B) to open the menu, select menu pages and change settings. See the Menu section on page **19** for information on using the menu features.

INPUT button

Press the **INPUT** button (E) repeatedly to cycle through the available digital inputs. The sequence is:

AES, USB, RCA1, RCA2, AES, etc.

When the menu is open, the **INPUT** button changes to the **<** button, used to page backwards through the menu.

OUTPUT Button

Use the **OUTPUT** button (F) to select the output sample rate / format. The sequence is:

32kS/s, 44.1kS/s, 48kS/s, 88.2kS/s, 96kS/s, 176.4kS/s, 192kS/s, DSD, 32kS/s, etc.

The output rate cannot be less than the input rate, so the lower rates may disappear from the list. Once the output rate is set, it is not affected by a change of digital input or input sample rate, unless the input rate exceeds the output rate. If this should happen, the output changes to match the input rate.

When the menu is open, the **OUTPUT** button changes to the **>** button, used to page forwards through the menu.

Remote Control Receiver

Aim the remote control handset (supplied with the Transport) towards the receiver (K) for best sensitivity.

Display

In normal use, the display (M) is split into 3 areas.

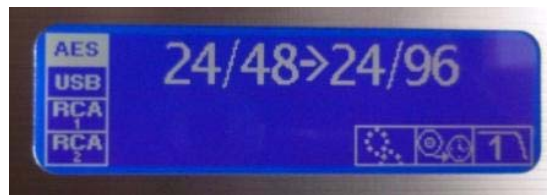

The section on the left side is the input indicator, showing the selected indicator highlighted (**AES** in the example above).

The section in the top centre shows the input data format on the left (**24** bits at **48kS/s** in this example) and the output data format on the right (**24** bits at **96kS/s** in this example). **No Input** on the left side indicates there is no data stream on the selected input. **0** bits on the left side indicates that a data stream is present but carries no audio data at the moment (for example when the tray of the CD Transport is open).

The three icons in the lower right corner indicate (starting from the left side):

- the Upsampler is locked. This icon disappears when the unit is not locked (or in Master mode), and greys out while the unit is attempting to lock.
- the Sync mode (sync'd to Audio in the example) and
- the selected filter (**Filter 1** in the example). When in Clone mode, this icon is replaced by the Clone icon.

In the second example below, the input indicator has changed to show that the **RCA1** input is selected. The sample rate section shows that the unit is receiving a **16** bit **44.1kS/s** data stream and converting it to **DSD**. The icons in the lower right corner indicate that the Upsampler is locked to an external clock, the Upsampler is sync'd to Word Clock and Filter **1** is selected.

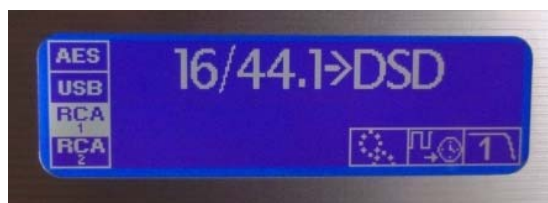

Details of the menu displays are shown in the Menu section on page **19**.

If the display is turned off on the **Display Settings / Display Off** menu page, the LED (L) above the display lights.

REAR PANEL

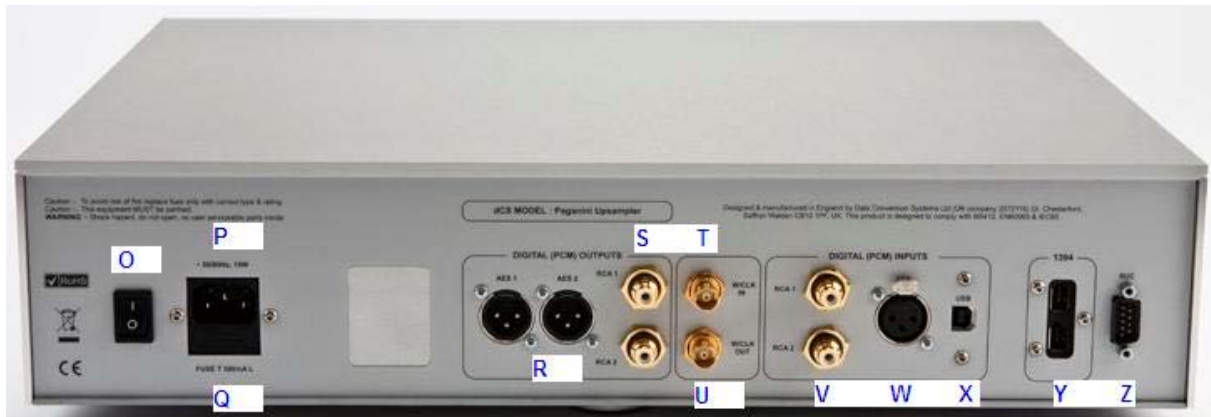

Figure 7 - Rear Panel

Digital Inputs

All the digital inputs will accept up to 24-bit PCM data at 32, 44.1, 48, 88.2 or 96kS/s.

The standard PCM inputs are **AES** on a 3-way female XLR connector (W), SPDIF inputs **RCA1** & **RCA2** on RCA phono connectors (V).

The **USB** interface on a 'B' type connector (X) will accept uncompressed music data from a Windows™ PC, MAC™ or sound server equipped with a USB 2.0 interface.



We have tested this interface with several common formats running on Windows™ Vista, Windows™ XP and MAC™ OSX but we cannot accept responsibility for correct operation with all source devices, operating systems or software.

Digital Outputs

All of the outputs consistent with the selected output mode are active at the same time.

All the single-wire PCM digital outputs generate 24-bit PCM data at 32, 44.1, 48, 88.2 or 96kS/s.



The *Paganini Upsampler* does not have facilities to reduce the output word length of PCM data to less than 24 bits. It will not give good results with older DACs or other equipment that cannot process 24-bit data. ALL *dCS* equipment will accept 24-bit PCM data.

The **AES1** and **AES2** outputs (R) can be used individually at up to 96kS/s or as a Dual AES pair at 88.2, 96, 176.4 or 192kS/s. These outputs are disabled in DSD mode.



For Dual AES operation at 88.2 or 96kS/s, the **Dual AES** menu page must be set to **On**, otherwise both outputs will carry single AES data.

2 SPDIF outputs are provided, **RCA1** and **RCA2**, on RCA phono connectors (S). These outputs carry SPDIF data for output rates up to 96kS/s, even if Dual AES mode is set. They are disabled if the output is set to 176.4 or 192kS/s or DSD.

The IEEE 1394 interface (Y) outputs encrypted DSD data. 1394 interfaces are great for carrying lots of digital data - but are very poor at transmitting a stable clock, so a separate Word Clock connection is required. The two 1394 ports are identical – they can be used as data outputs or as a pass-through. Note that the 1394 bus must not be connected in a loop as this will prevent the system initialising.

Word Clock Input / Output

The **W/Clock In** connector (T) will accept standard word clock from the source equipment or a master clock at 32, 44.1, 48, 88.2 or 96kHz. Unlike the DAC, the clock frequency does not need to be an exact multiple of the input data rate provided the two rates are synchronous. Set the **Upsampler Settings / Sync Source** menu page to **WClk** when locking to an external word clock. Note that the source (e.g. the CD Transport) **MUST** be locked to the same clock, otherwise the **SYSTEM** will not be locked and periodic clicks will be heard on the outputs.

The **W/Clock Out** connector (U) carries word clock at the same frequency as the single-wire output sample rate, or 44.1kHz for DSD. For example, if the output is set to 192kS/s Dual AES, the **W/Clock Out** connector carries a clock at half this rate – 96kHz.

Word clock is used for synchronisation only, it does not carry digital data.

SUC Connector

The **SUC** connector (Z) is an RS232 interface, primarily used to remotely control the unit during automated testing. Please contact *dCS* for advice on using this interface with a household automation system. Note that we recommend using infra-red remote control instead.

Mains inlet

Power is connected via a standard IEC320 connector (P), protected by a fuse (Q) and isolated by a 2-pole power switch (O).

THE MENU

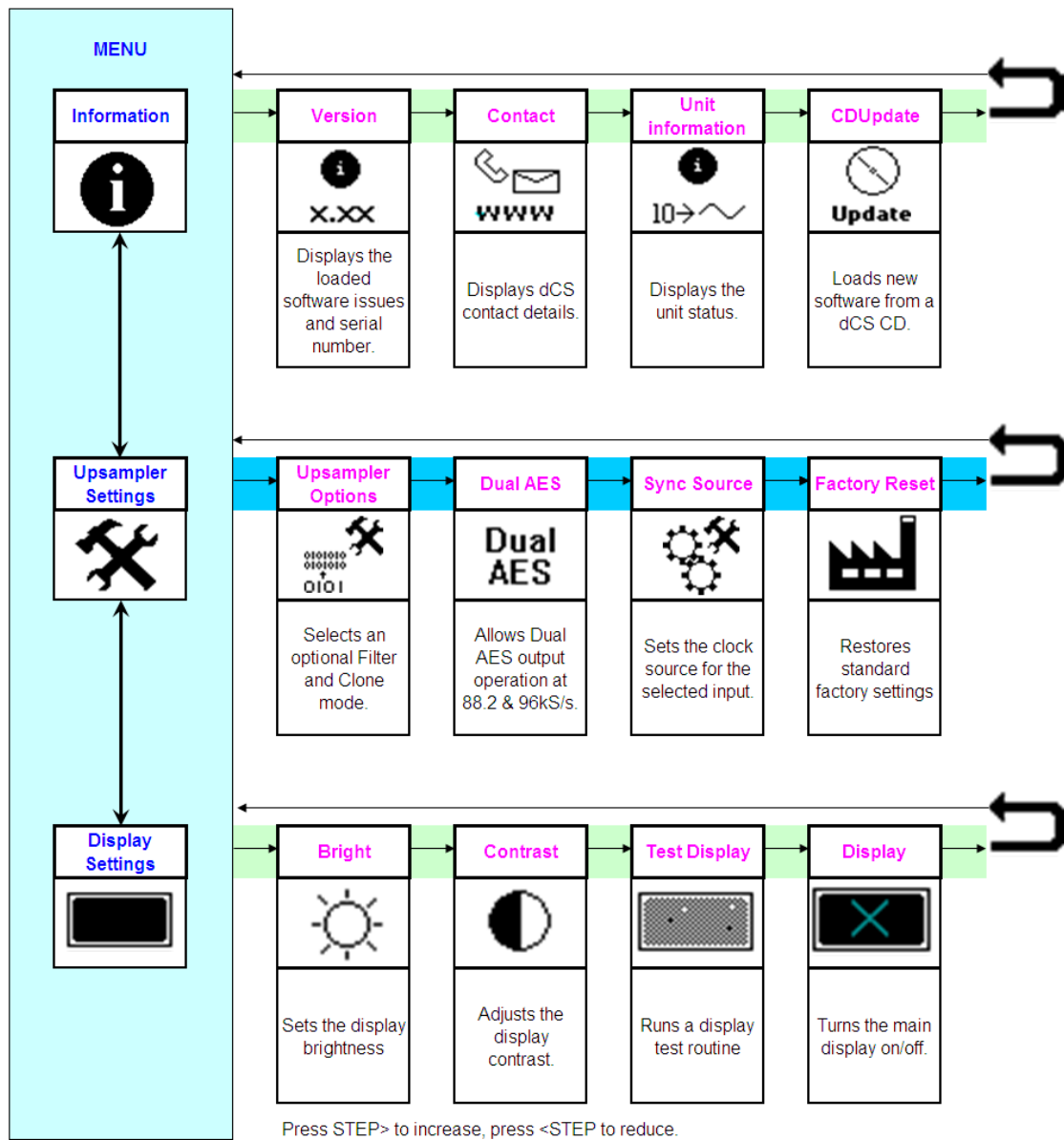

Figure 8 – The menu sequence

Using the Menu

The menu gives the user access to a range of additional features. It also allows new features and performance enhancements to be added at a later date by software upgrades.

The menu is controlled by four buttons.



Press the **MENU** button to open the menu or select a setting.
Press the **>** button to page forward through the menu.
Press the **<** button to page backward through the menu.
Press the **POWER** button to close the menu or just wait 5 seconds.

Use the Menu Guide sheet to help you find the right menu.

Each unit in the range has either three or four top-level menu pages:



The **INFORMATION** menu gives software issues, serial number, contact details and unit set-up details.



The **SETTINGS** menu allows you to set some features that are not directly accessible from the front panel.



The **DISPLAY SETTINGS** menu is used to adjust and test the display.

Use the **>** button to move the highlight to the menu you want, then press the **MENU** button to select it. The next menu level down is displayed. Use the **>** button to move the highlight to the menu page you want, then press the **MENU** button to display the information or change the setting.



Select the exit icon to go back to the previous menu level.

INFORMATION Menu

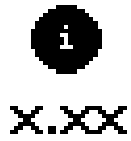

The **Version** page displays the software versions loaded in the unit and the full serial number. Please have this information ready if you contact your dealer for any reason.

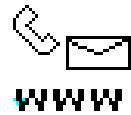

The **Contact** page displays *dCS* web-site URL, email address, telephone and fax numbers. If you have any difficulty, please contact your dealer for help first.

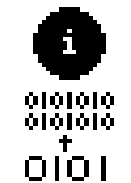

The **Upsampler Information** page displays the unit status:

- Audio Input: AES / RCA1 / RCA2 / USB
- Sync Source: Audio / WCk / Master
- Clone Mode: Off / On
- Input Sample Rate:
- Output Sample Rate:
- Wordclock Rate:
- Internal temperature°C

Use the **< STEP >** buttons to scroll down the list and press the **MENU** button to exit.



The **CD Update** feature allows you to load new software into your *Paganini Upsampler*. Please follow the instructions supplied with the update CD or file carefully.

While the input sample rate is not 44.1kS/s, CD Updating is not possible and so the icon will be greyed out. Use the front panel controls during an update as the remote control may not operate.



If you accidentally start a CD Update, either switch off the unit at the back panel switch, wait 10 seconds, then switch on again or just wait until the unit aborts the update.

UPSAMPLER SETTINGS Menu



The **Upsampling Options** menu page opens a lower level with two more pages. These select optional anti-aliasing **Filters** and select **Clone** Mode.

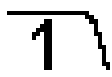

The optional **Filters** give different trade-offs between impulse response and aliasing. The table below shows how many filter choices are available for each combination.



		OUTPUT RATE							
		32k	44.1k	48k	88.2k	96k	176.4k	192k	DSD
INPUT RATE	32k	1	1	1	1	1	1	1	1
	44.1k		2	2	5	2	5	2	6
	48k			1	1	4	1	4	1
	88.2k				1	1	1	1	4
	96k					1	1	1	1

For most conversions, only **Filter 1** is available - a classic sharp filter. The amplitude is reduced by 0.1dB to match the other filters.

For conversions with 2 filters (currently all of these have a 44.1k input rate):
Filter 1 is a classic sharp filter. The 44.1k→44.1k conversion has no filtering, the level is reduced by 0.1dB.

Filter 2 is a very steep, long apodising filter which starts rolling off at 20kHz (19kHz for the 44.1k→44.1k conversion). This filter is asymmetric – there is no energy left in the output to exercise the DAC's filter, so there is no pre-ringing from the source and the DAC. This will improve the response of the DAC's reconstruction filter by removing some high frequency components that typically cause images in half-band filter DACs.

For conversions with 4 filters:

Filter 1 has the sharpest cut-off, and so has the poorest impulse response (transient performance) but the best alias rejection (removal of out-of-band frequencies).

Filters 2, 3 and **4** have progressively gentler cut-off, with less alias rejection.

For conversions with 5 filters (currently all of these have a 44.1k input rate):

Filters 1 – 4 are the same as for conversions with 4 filters.

Filter 5 is an apodising filter as described above.

For the 44.1k→DSD conversion which has 6 filters:

Filters 1 – 4 are the same as for conversions with 4 filters.

Filter 5 is an asymmetrical design with non-linear phase and no pre-ringing.

Filter 6 is a new long filter which has linear phase and pre-ringing.

The best filter setting is a personal choice and may be related to the type of music.



With the **Clone Mode** page set to **Clone On** and the output sample rate set to be equal to the input sample rate, PCM data passes through the Upsampler unchanged (bit-perfect). The Clone icon appears on the display to indicate the output is bit-perfect.



If the input and output sample rates change so that they no longer match, the unit will stop cloning and the clone icon will disappear.

This mode is useful when passing HDCD data through unchanged to a (non-dCS) HDCD converter, or for CD Updating a dCS DAC via the Upsampler.



Set to Clone Lock, the output rate automatically changes to match any change in the input rate, locking the unit in clone mode. The Clone Lock icon appears on the display.



Set to **Clone Off**, the unit upsamples as directed by the control setting and so the data is changed. This is the usual setting.



Clone mode is not available if the output rate is 176.4kS/s, 192kS/s or DSD. Filters are disabled in Clone mode, as filtering prevents bit-perfect operation.

Dual AES

The **Dual AES** menu page sets the output mode when the output sample rate is 88.2 or 96kS/s ONLY. When set to **Dual AES On**, a stereo pair is split between the **AES1** and **AES2** outputs, they MUST be used together as a pair. Each wire runs at half the sample rate (44.1 or 48kHz respectively). The left channel data appears on the **AES1** output, the right channel data appears on the **AES2** output.

Dual AES is automatically selected when the output sample rate is set to 176.4 or 192kS/s.

When set to **Dual AES Off**, both **AES1** and **AES2** outputs carry the same single AES data at the sample rate (88.2 or 96kS/s respectively). Using these together in Single AES mode is NOT the same as a Dual AES pair.



The **Sync Source** menu sets the clock source individually for each Upsampler input.



Set to **Audio**, the unit extracts the clock from the selected digital input and locks to it. The Sync icon appears on the front panel, greyed-out during locking. When locking is complete, the Sync icon firms up. The Upsampler's PLL will reduce the clock jitter, but this mode does not give the best jitter performance. Sync to **Audio** is not available when the USB input is selected.



If the **USB** input is selected but a Master Clock is not available, the Upsampler may be set to **Master** mode. In this mode, the Upsampler's internal clock controls the system timing, so Sync does not appear on the display.



Set to **W/CLK**, the Upsampler locks to an external Word Clock connected to the **W/CLK In** connector. The Sync icon appears on the front panel, greyed-out during locking. When locking is complete, the Sync icon firms up. This setting gives best results when using a Master Clock to sync the whole system.



This icon is displayed if the Word Clock input is not connected, or if the Word Clock frequency is not recognisable.



The **Sync Source** setting is stored separately for each input. Select the required input before changing the **Sync Source** setting.



The **Factory Reset** menu page resets the unit to standard settings. These are:

Input to **AES**.

Output to **96kS/s**

Sync to **Audio** Input for PCM.

Sync to **Master** Mode for USB.

Filter to 1.

Dual AES to **On**.

Display to **On**.

Brightness to 80%.

Contrast to 60%.

DISPLAY SETTINGS Menu

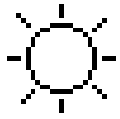

Set the display **Brightness** to a comfortable level using the < and > buttons.



Set the display **Contrast** to a comfortable level using the < and > buttons.



Runs a **Display Test** routine, which flashes all the indicators and the main display.



The **Display On / Off** menu page controls the display and LED indicators.



Select the page once and the display will turn off after the menu times out. The blue LED over the display illuminates to show the display has been turned off. Operating the controls turns the display back on briefly.



Select the page a second time to turn off the **DISPLAY OFF** LED also after the menu times out. Select the page a third time to turn the display back on.

SPECIFICATION

Digital inputs	USB interface on a B-type connector, will accept up to 24 bit PCM at 32, 44.1, 48, 88.2 or 96kS/s. Operates in asynchronous mode.
	AES3 on a 3-pin female XLR connector, will accept up to 24 bit PCM at 32, 44.1, 48, 88.2 or 96kS/s.
	2x SPDIF on 2x RCA Phono connectors. Each will accept up to 24 bit PCM at 32, 44.1, 48, 88.2 or 96kS/s.
Digital outputs	IEEE 1394 interface on 2x 6-way connectors. In DSD mode, the interface outputs <i>dCS</i> -encrypted DSD (1 bit data at 2.822MS/s).
	2x AES3 on 3-pin female XLR connectors. Each outputs 24 bit PCM at 32, 44.1, 48, 88.2 or 96kS/s, OR as a Dual AES pair at 88.2, 96, 176.4 or 192kS/s.
	2x SPDIF on RCA Phono connectors. Each outputs 24 bit PCM at 32, 44.1, 48, 88.2 or 96kS/s.
Clocking	Word Clock Input on 1x BNC connector, accepts standard word clock at 32, 44.1, 48, 88.2 or 96kHz. Sensitive to TTL levels.
	Word Clock Output on 1x BNC connector, outputs standard word clock at a frequency equal to the (single wire) output data rate, or 44.1kHz when set to output DSD.
Upsampling rates	Data from any input may be converted to 24 bit PCM at 32, 44.1, 48, 88.2, 96, 176.4 or 192kS/s or DSD (1 bit data at 2.822MS/s). The output sample rate must be equal to or greater than the input sample rate.
Spurious responses	Better than -100dB0, 20Hz-20kHz
Optional filters	A choice of filter is available for 10 popular conversions, see page 22 for details.
Size and weight	460mm (18.1") W x 400mm (15.8") D x 110mm (4.4") H including feet. Allow extra depth for cable connectors. Allow space for air flow around the unit.
	Weight 10.6kg (23.3lbs).
Power requirements	Internally set to either 100, 115/120, 220 or 230/240V AC, 49 – 62Hz.
	Power consumption: 12.7 W typical, 15 W maximum.

These specifications are subject to change without notice.

MAINTENANCE AND SUPPORT

Service and Maintenance

dCS audio products are designed not to need regular maintenance, and contain no user serviceable parts apart from the mains fuse. If your unit is damaged in any way, please contact your dealer.

Replacing a Blown Mains Fuse

There is a mains fuse below the power inlet, accessible from the outside of the unit. If the fuse blows, it may be changed by the user. The current consumption of the unit is very low, so it only blows if power surges occur, or there is a fault in the unit. Usually power surges cause no other damage, but if the fuse blows repeatedly on replacement, some other damage will have been done and the unit will need to be repaired.

Fuse type: 20mm x 5mm T0.5 amp L fuse



If the fuse should fail, it is essential that it is replaced with one of the same type and rating. Failure to do so could result in damage to the unit, risk of fire or electric shock and will invalidate the warranty.

Referring to the diagram below, remove the power cable, use a small flat bladed screwdriver to pry up the tab on the fuse carrier (A) and pull it out. Push the blown fuse out of the clip in the carrier (B) and dispose of it. Fit a new fuse in the clip (C) and push the carrier back into the unit so that it clicks home. Spare fuses are provided with the unit.

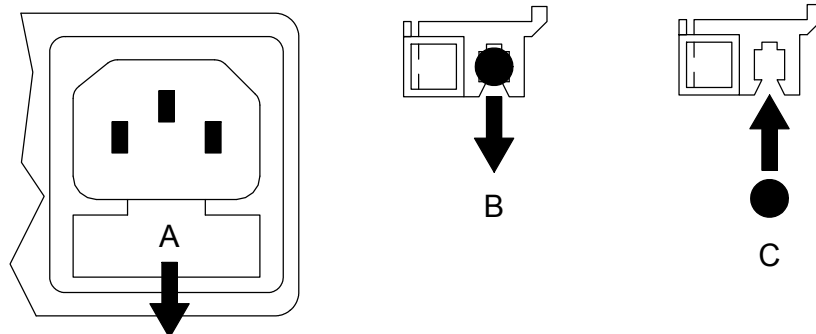

Cleaning the case

The front panel of your dCS equipment is machined from very high grade aluminium. Great care has been taken to create the finish of the aluminium throughout the engineering process from the raw solid material to the finished piece.

To remove loose dust or finger marks from the case, we recommend that you use a clean, dry, lint-free cloth.

To restore the finish on the front panel, we recommend applying small quantities of a lanolin based cleaner, using a clean, dry, lint-free cloth and then wiping off. Do not allow lanolin to collect around the buttons.

Small amounts of glass cleaner containing ammonia may be used to clean other surfaces, but avoid spraying onto the connector contacts.

Limited Warranty

General

dCS warrants this product against defects in materials and workmanship for a period of 3 years from the date the unit was originally shipped from *dCS*. During the warranty period, *dCS* will repair or, at our absolute discretion, replace a faulty product. Warranty repairs must only be carried out by *dCS* or our authorised service agents. Please contact your dealer if your unit requires service.

Your dealer should have completed on your behalf an **Owner Registration** form at the time of sale and returned it to *dCS*. On receipt of the Owner Registration form, *dCS* will add your contact details to our customer database. *dCS* will use this information for warranty and customer support purposes only.

This warranty applies to the original owner.

Warranty Exclusions

The Warranty does not cover:

- wear and tear.
- shipping charges or tax/duty.
- products re-sold by *dCS* on a “used” basis – these will be subject to reduced warranty terms.

The Warranty on this product will be voided if:

- the product is misused in any way.
- any unauthorised modifications or repairs are carried out.
- the product is not used in accordance with the Operating Conditions stated in this manual.
- the product is serviced or repaired other than by *dCS* or our authorised service agents.
- the product is operated without a mains earth (or ground) connection.
- the unit is returned inadequately packed.

dCS reserve the right to apply a service charge if a product returned for warranty repair is found to be operating correctly, or if a product is returned before a *dCS* returns number has been issued.

Our dealers or distributors are NOT authorised to extend the terms of this warranty, *dCS* cannot accept responsibility for any attempt to do so.

Obtaining Service

Should you encounter a problem, contact your authorised *dCS* dealer for advice, quoting the model, the full serial number, software version number, and giving a detailed description of the fault. Your dealer will advise you fully on actions that need to be taken. When returning a unit, the original packaging should be used to avoid transit damage. Replacement packaging sets may be purchased from *dCS*.

During the Warranty period, there will normally be no charge for parts or labour.

Operating Conditions

- The supply voltage must remain within +/-10% of the A.C. voltage specified on the back panel.
- The supply frequency must be in the range 49Hz to 62Hz.
- Ambient temperature range: 0°C (32°F) to 40°C (104°F), non-condensing.
- Do not install the unit near heat sources such as radiators, air ducts, power amplifiers or direct strong sunlight.
- If in doubt, the easy test is – the unit is happy to work anywhere a human is.

If you need more help

In the first instance, you should contact your dealer. If they cannot resolve the issue, contact your national distributor.



dCS, our dealers and distributors cannot accept responsibility for I.T. support issues. In such cases, please ask the computer or software vendor for advice.

Manufactured by:

Data Conversion Systems Ltd.
Unit 1, Buckingway Business Park,
Anderson Road,
Swavesey,
Cambridge. CB24 4AE
UK

www.dcsltd.co.uk

This user manual may be downloaded free of charge from our web-site. A bound copy of this manual may be ordered from dCS.

Software History

dCS products make extensive use of software configurable chips – FPGAs and DSPs. This gives us the ability to update our products to add extra features, update digital interface standards or make performance improvements by loading new software. Occasionally, a hardware upgrade may be necessary also to increase the “capacity” of the electronics, add extra connectors or extra front panel controls.

Please note that not all software updates make an earth-shattering change. You should have a clear idea of what you expect to gain before updating to the latest issue. We recommend that you keep your software up to date. Check the dCS web-site for the latest software updates.

This manual is for *Paganini Upsampler* software version 1.1x.

Issue 1.00 - The first issue with 1394 v4.02.

Issue 1.01 – Adds a remote code to change output sample rate.

Optional filters added for 48k>192k conversion.

Changes some icons to avoid display flicker.

Issue 1.02 – 96k USB bug fixed.

Issue 1.10 – Filter choices are now available for 10 conversions, including asymmetrical (sometimes called apodising) filters for all conversions from 44.1kS/s.

USB code updated to improve compatibility with Windows Vista / Windows 7 WASAPI mode and Spotify. This updates the 1394/USB code version to v4.05.

Clone Lock mode added.

Word Clock Output frequency is now 88.2 / 96kHz when output rate is 176.4 / 192kS/s.

LEDs off feature added to Display On/Off menu.