

*dCS Paganini DAC*  
Stereo Digital to Analogue Converter

**User Manual**  
Software Release 1.0x  
June 2008

© Data Conversion Systems Ltd. 2007-8

**Price UK £8.00 / Euro 12.00**

All rights reserved. No part of this publication may be reproduced, stored in or introduced into a retrieval system, or transmitted in any form, or by any means (electronic, mechanical, photocopying, recording or otherwise) without the prior written permission of *dCS*<sup>1</sup>. Any person who does any unauthorised act in relation to this publication may be liable to criminal prosecution and civil claims for damages.

Information contained in this manual is subject to change without notice, and whilst it is checked for accuracy, no liabilities can be accepted for errors.

---

<sup>1</sup> *dCS* is Data Conversion Systems Ltd. Company registered in England No. 2072115.



## CONTENTS

<b>Contents .....</b>	<b>3</b>
<b>Using the dCS Paganini DAC for the first time .....</b>	<b>4</b>
What's in the box?	4
Safety Notice	4
Mains Voltage Setting	4
Power Cables	5
Mains Regenerators	5
Positioning the unit	5
Disposal at end-of-life	5
<b>Step-by-Step Guide .....</b>	<b>6</b>
Preliminaries	6
STEP 1 – Selecting a Digital Input	7
Connecting to an IEEE 1394 DSD Source	7
Connecting to a Single AES or SPDIF source	7
Connecting to a Dual AES Source	7
STEP 2 – Connecting the Analogue Outputs	8
Using a preamplifier	8
Using a power amplifier directly	8
STEP 3 - Setting the Output Level	9
STEP 4 – Choosing a Sync Mode	10
Using the DAC in Master Mode	10
Using a Master Clock	11
<b>Front Panel .....</b>	<b>12</b>
POWER Button	12
MENU Button	12
INPUT button	12
MUTE Button	12
SYNC Button	13
FILTER Button	13
Remote Control Receiver	13
Display	14
Rotary Control	14
<b>Rear Panel .....</b>	<b>15</b>
Mains inlet	15
Analogue Outputs	15
Word Clock Input / Output	15
SPDIF Digital Inputs	15
AES Digital Inputs	15
1394 Interface	16
SUC Connector	16
<b>The Menu .....</b>	<b>17</b>
Using the Menu	18
INFORMATION Menu	19
DAC SETTINGS Menu	20
DISPLAY SETTINGS Menu	20
<b>Specification .....</b>	<b>21</b>
<b>Maintenance and Support.....</b>	<b>22</b>
Service and Maintenance	22
Replacing a Blown Mains Fuse	22
Cleaning the case	22
Limited Warranty	23
If you need more help	24
Software History	24

---

## USING THE *dCS Paganini DAC* FOR THE FIRST TIME

Congratulations on purchasing your *dCS Paganini DAC*.

Before using your unit, please read this section and the Step by Step Guide. This will enable you to set the unit up quickly and safely with your hi-fi system.

From time to time, *dCS* will release updated software on CD that you can install yourself using the **CD Update** feature. Please check our web-site occasionally to see if new *Paganini* software is available, or consult your dealer.

### What's in the box?

Check that the box contains the following items:

- *dCS Paganini DAC*
- Manual and Menu / Setup Guide
- Power cable
- 1394 cable
- BNC cable
- 2 RCA to BNC adapters
- 2 spare fuses

Notify your dealer as soon as possible if anything is missing or damaged. We suggest that you retain the original packaging for possible future use. If this is not possible, replacement packaging can be ordered from *dCS* or our distributors. Details can be found on our web site at [www.dcsltd.co.uk](http://www.dcsltd.co.uk).

The cables supplied are commercial-grade parts, as we realise our customers will want to make their own choices.

The *Paganini Transport* is supplied with a remote control. If you do not have a *Paganini Transport* in your system, a remote control can be ordered direct from *dCS* as an optional extra.

### Safety Notice

Your *dCS Paganini DAC* contains no user serviceable parts. **DO NOT** attempt to open the case as there are potentially dangerous voltages present inside. In the event of the unit developing a fault, please contact your dealer in the first instance.

To maintain protection from electric shock, each unit in the *Paganini* system **MUST** be connected to mains earth (ground) via the power cable.

Also, unearthed systems do not give the best sonic performance.

### Mains Voltage Setting

Before connecting the power cable to the unit for the first time, please check that it has been set to the correct operating voltage for your mains supply. The unit's voltage setting is shown on the label beneath the mains inlet on the rear panel. If this does not match your local supply voltage, **DO NOT** attempt to use the unit. Contact your dealer to have the unit reset. Using the unit with the wrong mains setting for your local supply may result in serious damage to the unit and will invalidate the warranty. Do not attempt to reset the voltage yourself.

## Power Cables

If you wish to use a power cable other than the one supplied, please ensure that it is a good fit to the mains inlet, and is not so heavy and inflexible as to place strain on the mains inlet.

## Mains Regenerators

We do not recommend the use of mains regenerators. However, if you do wish to use a mains regenerator with variable voltage and frequency, we recommend that you set the voltage to match your local voltage and the frequency to either 50Hz or 60Hz ONLY.



Damage caused to your *Paganini DAC* by misuse of a mains regenerator or by a malfunctioning mains regenerator is not covered by the warranty.

## Positioning the unit

Units in the *Paganini* range may be stacked directly on top of each other, but are likely to give better sonic results when mounted on separate shelves of a rack. Place each unit on a firm, vibration free base, allowing convenient connection to the other parts of your system. To prevent overheating, we recommend that you leave some free space around the unit to allow for ventilation.

3 feet are fitted as standard, this may be changed to the 4-foot arrangement shown below, if you prefer. Spare feet are available as an optional extra. The mounting points are M4 size, maximum screw depth is 10mm.

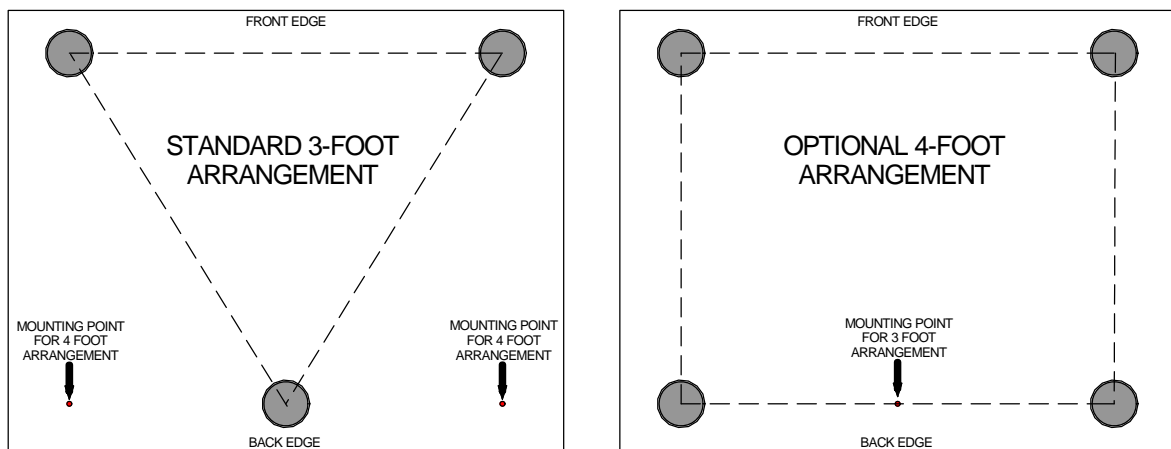

## Disposal at end-of-life



The symbol indicates that this product should not be treated as normal household waste. It should be recycled, so please take it to an approved collection facility.

---

## STEP-BY-STEP GUIDE

This section guides you through setting up the unit for basic operation.

### Preliminaries

The Menu / Setup Guide sheet details the menu structure and details the two most common set-ups.

For digital interfaces, use with cables designed for digital audio:

- for AES/EBU interfaces use 110 $\Omega$  screened, twisted pair cables fitted with one male XLR connector and one female XLR connector.
- for Word Clock interfaces, use 75 $\Omega$  coax cables fitted with BNC plugs.
- for SPDIF RCA interfaces, use 75 $\Omega$  coax cables fitted with RCA Phono plugs.
- for IEEE 1394 interfaces, use the IEEE 1394 cable provided with the unit.

For analogue outputs, use with screened cables of the correct type:

- for balanced outputs, use screened, twisted pair cables fitted with one male XLR connector and one female XLR connector.
- for unbalanced outputs, use coax cables fitted with RCA Phono plugs.

Connect the power cable supplied to the power inlet on the DAC rear panel, plug the other end into a convenient power outlet.



Please do not use an excessively heavy or inflexible power cable as this may damage the power inlet connector.

Set the rear panel power switch to the **I** position. Briefly press the **Power** button and wait about 30 seconds while the DAC configures itself. The display will show in sequence: **Paganini DAC** and **No Input**.

If the unit is likely to be set in an unfamiliar state, you can reset it as follows:

Press the **Menu** button, press the **→** button once, then the **Menu** button again to display the **DAC Settings** menu. Press the **←** button repeatedly to highlight the **Factory Reset** menu page. Press the **Menu** button and wait a few seconds while the settings are reset.

---

## STEP 1 – Selecting a Digital Input

Switch on the source equipment. If appropriate, load a disk / tape and set the machine in PLAY mode to ensure it is generating a digital audio data stream.

Choose one of the following sections:

### Connecting to an IEEE 1394 DSD Source

- Check that your source equipment (probably a *dCS* SACD Transport or a *dCS* Upsampler) follows the *dCS* protocol, generates a 44.1kHz word clock and is set up correctly.
- Connect **one** 1394 output on your source equipment to **one 1394** input on the *DAC* rear panel. Also connect the word clock output on your source equipment to the **W/Clk In** connector on the *DAC* rear panel.
- Press the **Input** button repeatedly until **1394** or the source name is displayed (probably **dCS PTT**).

The unit may display **Wait ...**, **No-WClk** or **Search...**, messages if the unit is still settling, then in sequence (**Clk OK**), **Locking**, **None**. If you have more than one source connected to the 1394 bus, it may be necessary to use the **Input** button to select the 1394 source you want to listen to.

### Connecting to a Single AES or SPDIF source

Most source equipment (such as CD transports, DVD players) is fitted with a single wire digital output, usually on an RCA phono connector.

- Connect your source equipment to the matching input on the *DAC* rear panel using a suitable cable.
- Press the **Input** button repeatedly until your chosen input is displayed. This will be either **AES1**, **AES2**, **RCA1** or **RCA2**.

The *DAC* will lock to the source, displaying in sequence (**44.1k**), **Locking**, **16/44.1** for example, if the source is a CD player.

If your source equipment is fitted with BNC output connectors instead of RCA phono connectors, fit an RCA-to-BNC adapter (supplied with the unit) to the *DAC*'s **RCA1** or **RCA2** input and connect using a BNC cable.

### Connecting to a Dual AES Source

Check that your source equipment is capable of Dual AES operation.

- Connect the AES1 (or AES A) output on your source equipment to the **AES1** input on the *DAC* rear panel and the AES2 (or AES B) output to the **AES2** input, using two XLR cables. Ensure the cables are not swapped.
- Press the **Input** button repeatedly until both **AES1** AND **AES2** input indicators are lit.

The *DAC* will lock to the source, displaying in sequence (**96k**), **Locking**, **24/192** for example, if the source is 24 bit data at 192kS/s.

**Proceed to Step 2.**

## STEP 2 – Connecting the Analogue Outputs

Choose one of the following two sections:

### Using a preamplifier

- Set the preamplifier volume control to minimum.
- Connect either the balanced (XLR connectors) or unbalanced (RCA phono connectors) outputs on *DAC* rear panel to matching line level inputs on your preamplifier (probably labelled CD or AUX).
- Turn the *DAC* rotary control clockwise to set the **Volume** to maximum (**- 0.0dB** on the display).

Slowly increase the preamplifier volume until the music is at the desired level.

### Using a power amplifier directly

- Turn the *DAC* rotary control counter-clockwise to set the **Volume** to minimum (**-60.0dB** on the display).
- Connect either the balanced (XLR connectors) or unbalanced (RCA phono connectors) outputs on the *DAC* rear panel to matching inputs on your power amplifier. Switch on the power amplifier.
- Turn the *DAC* rotary control slowly clockwise until the music is at the desired level.

Play a disc, you should have audio.

The balanced and unbalanced outputs are separately buffered, you can connect both at the same time if required.

Proceed to Step 3.

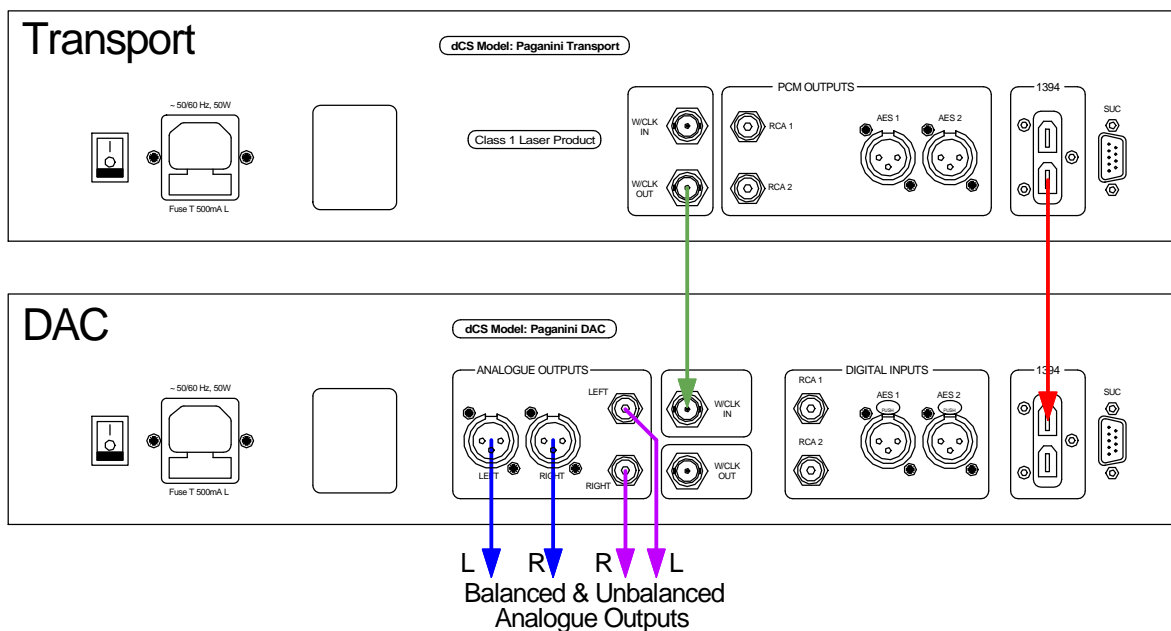

Figure 1 – Basic setup

### STEP 3 - Setting the Output Level

If the preamplifier volume setting for a comfortable listening level is too high or too low, you may need to change the **Output Level** setting.



Setting the **Output Level** to **6V** can cause some preamplifiers to overload and distort. For this reason, we recommend the **2V** setting if a preamplifier is used.

Similarly, if you are driving a power amplifier directly and the **DAC Volume** setting for a comfortable listening level is higher than **-10.0** or lower than **-20.0**, try changing the **Output Level** setting.

- Press the **Menu** button, press the **Sync** button once, then the **Menu** button again to display the **DAC Settings** menu. Press the **Sync** button repeatedly to highlight the **Analogue Out** menu page. Press the **Menu** button to change the setting.

If the setting is **2V** and the **Volume** is still set well below **-20.0**, try some passive attenuators.



The output level relays can flip over in transit, resulting in one or both channels having a lower or higher level than expected. This can be corrected by changing the **Analogue Out** setting then changing back to the original setting.

## STEP 4 – Choosing a Sync Mode

So far, the system has been set up to lock to the clock generated by the source. If you are using the 1394 interface, the DAC will lock to a word clock generated by the source. This is the simplest arrangement, but it does not give the best sonic performance due to clock jitter.

### Using the DAC in Master Mode

If your CD transport (or other source equipment sampling at 44.1kS/s) has a word clock input, you can reduce the jitter in your system by using the *DAC* in Master mode and slaving the source to it. If not, you can miss out this section.



You can use Master Mode **ONLY** if your source equipment can lock to a 44.1kHz word clock and the DAC is receiving data at 44.1, 88.2 or 176.4kS/s or DSD. If the system is not set up correctly and fails to lock, you will hear clicks / noises from the speakers and the signal may mute occasionally.

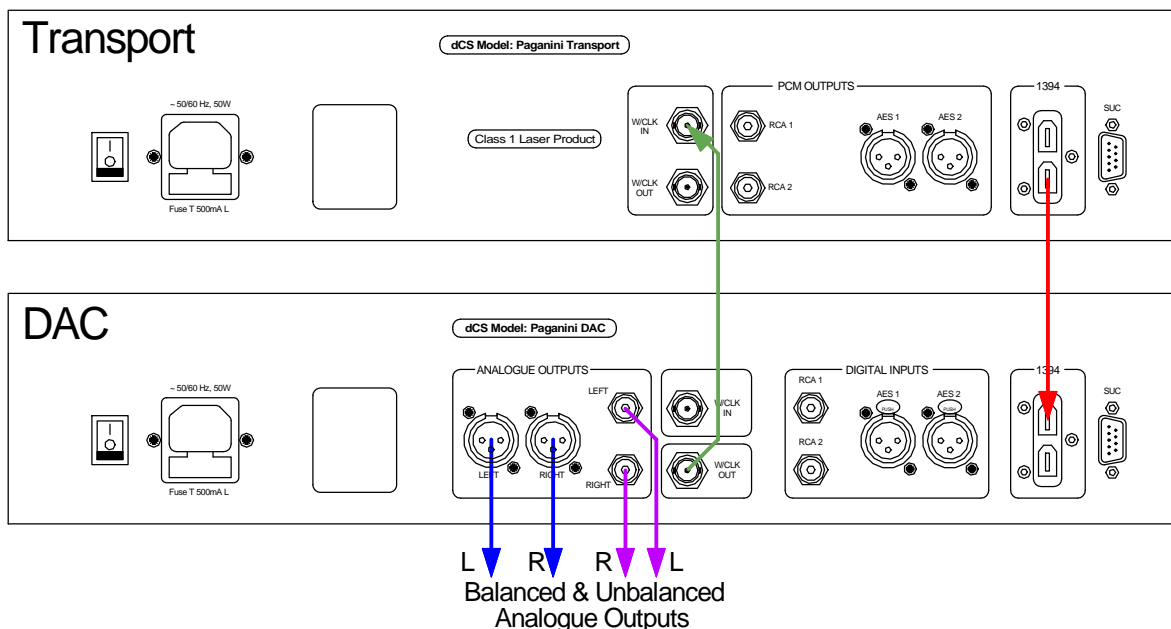

Figure 2 – Using the *Paganini* Transport with the DAC in Master Mode

- Connect the *DAC*'s **WClk Out** connector to the word clock input on the source equipment. *dCS* transports slave automatically.
- Press the **Sync** button to set the DAC to **Master** mode and allow the system to re-lock.

## Using a Master Clock

The performance can be improved further by adding a *Paganini* Clock to the system as shown below.

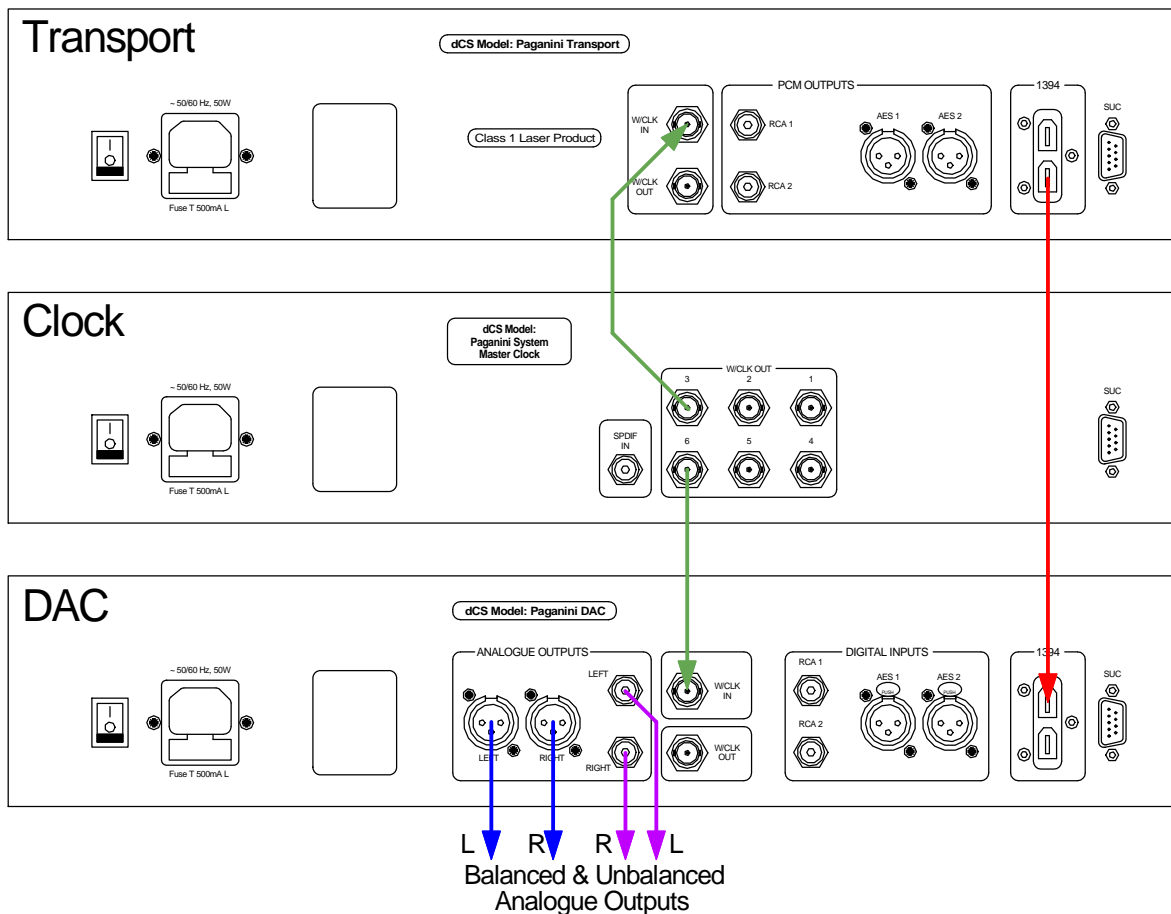

Figure 3 – Using the *Paganini* Transport , DAC and Clock together

- Connect two of the Clock's **W/Cik Outputs** to the **W/Cik Inputs** of the Transport and DAC.
- Use the Clock's **Frequency** button to set the outputs to **44.1kHz**, to suit the CD Transport.
- Use the DAC's **Sync** button to set the sync mode to **W/Cik**.

The system will re-lock and un-mute.

Please consult the Clock manual for more information on using a Master Clock.

The next step is crucial – sit back and enjoy the music.

## FRONT PANEL

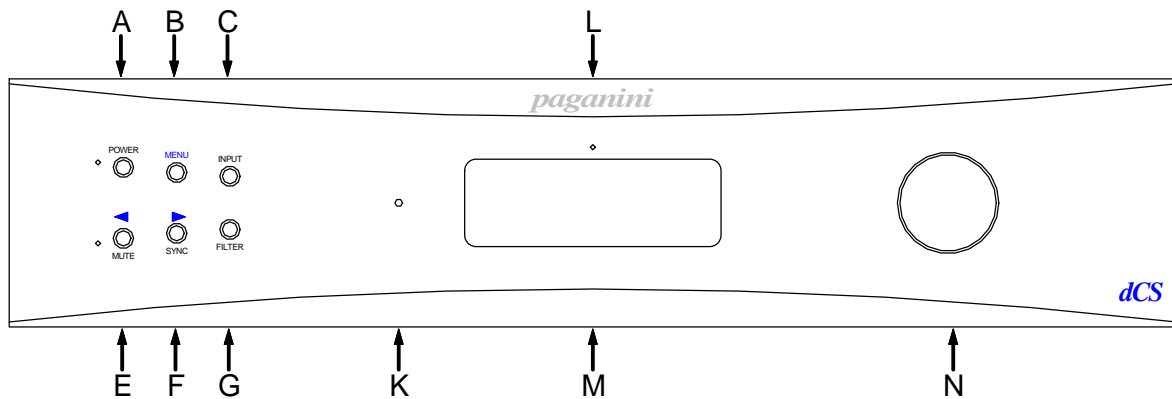

Figure 4 – Front panel

### POWER Button

To switch on, ensure the rear panel switch is set to **I** and press the **POWER** button (A) on the front panel once. Note that the unit cannot be turned on from the remote control.

To set the unit to sleep mode, press the **POWER** button once. The main display will turn off, the LED to the left of the button will illuminate, and the analogue outputs will mute, but the unit will remain close to running temperature. Press again to return to normal operation.

To switch off, hold down the **POWER** button for about 5 seconds until **Power Down** appears on the display, then release it.

When the menu is open, press the **POWER** button to close the menu.

### MENU Button

Press the **MENU** button (B) to open the menu, select menu pages and change settings. See the Menu section on page **17** for information on using the menu features.

### INPUT button

Press the **INPUT** button (C) repeatedly to cycle through the available digital inputs. The sequence is: **AES1**, **AES2**, **DUAL AES**, **RCA1**, **RCA2**, **1394** (the name of an active source will be displayed, e.g. **dCS PTT**). **DUAL AES** disappears from the list if it is turned off in the **DAC Settings / Dual AES** menu).

### MUTE Button

Use the **MUTE** button (E) to mute the analogue outputs. When the unit is muted (either manually or when not locked to a source) the LED to the left of the button illuminates.

When the menu is open, the **MUTE** button changes to the **<** button, used to page backwards through the menu.

## SYNC Button

Use the **SYNC** button (F) to set the sync mode for the digital input that is currently selected. The DAC remembers the Sync setting separately for each digital input. The three options are:

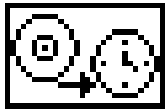

**Audio** – The DAC extracts the clock from the selected digital input and locks to it. (Note that this setting is not available when the **1394** input is selected.) Use this setting for systems that do not have a *dCS* Transport. This arrangement does NOT give the best jitter performance or the best sound quality.



**Master** – The DAC uses its own stable 44.1kHz clock and outputs the same clock on the **W/Cik Output**, so that the source can lock to the DAC. For correct master mode operation, the source equipment **MUST** be locked to the DAC. This is the recommended setting if you have a *dCS* Transport, but not a *dCS* Clock.

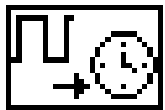

**W/Cik** – The DAC locks to an external clock connected to the **Word Clock Input**. This is the normal setting if you are using a *dCS* Transport or have the full stack. For the very best sound quality, use the this setting with the full stack.

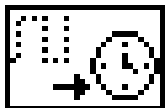

When the DAC is set to **W/Cik**, this icon appears for a few seconds while locking to the external word clock, then normally changes to the icon above. If the DAC cannot recognise the word clock frequency, it will fail to lock and the sync mode will change to **Audio**.

When the menu is open, the **SYNC** button changes to the **>** button, used to page forwards through the menu.

## FILTER Button

Use the **FILTER** button (G) to select your preferred filter, the current selection is shown in the top right corner of the display. This is a personal preference and is best done by ear. The choice of filter may depend on the type of music you are listening to.

In PCM mode, the first 4 filters give different trade-offs between the Nyquist image rejection and the transient response. Filter 1 has the best rejection of (unwanted) Nyquist images and the sharpest roll-off, resulting in the poorest transient response of the four. **Filter 2** is often preferred for orchestral music, while **Filter 3** and **Filter 4** are often used for rock music. Two extra filters are available when receiving data at 176.4 or 192kS/s: **Filter 5** is a Gaussian filter and **Filter 6** is an IIR filter, which features almost no pre-ringing.

DSD mode has 4 filters, but these progressively reduce the out-of-band noise level (which is inherent in the 1-bit nature of DSD). **Filter 1** is the usual setting – it gives the widest bandwidth (about 70kHz) and the highest level of out-of-band noise. If your system sounds harsh, try **Filter 2** or **Filter 3**. These progressively reduce the out-of-band noise level at the cost of some bandwidth. **Filter 4** is primarily intended for troubleshooting, not listening, as it has an early cut-off, designed to minimise the out-of-band noise.

The DAC remembers the last filter set for every sample rate.

## Remote Control Receiver

Aim the remote control handset (supplied with the Transport) towards the receiver (K) for best sensitivity.

## Display

In normal use, the display (M) is split into 4 areas.

The section on the left side is the input indicator, showing the selected indicator highlighted (**1394** in this example). Other available inputs are also indicated. For example, here the indicator also shows that the **AES1** input is receiving data at **96kS/s**, the **W/Clk Input** is locked to a **44.1kHz** clock and the other inputs (displaying **--**) are not connected to a recognisable source.

The section in the top centre shows the name of the 1394 source (**dCS PTT** in the example) or, for PCM sources, the word length and sample rate (such as **16/44.1**, **24/96** or **24/176.4**). While the unit is locking to a source, **Locking** appears here. **No Audio** indicates that no audio data is being received (this can happen between tracks). **No Input** indicates there is no data stream on the selected input.

The two icons in the top right corner indicate the Sync mode (locked to Word Clock in the example) and the selected filter (**Filter 2** is shown).

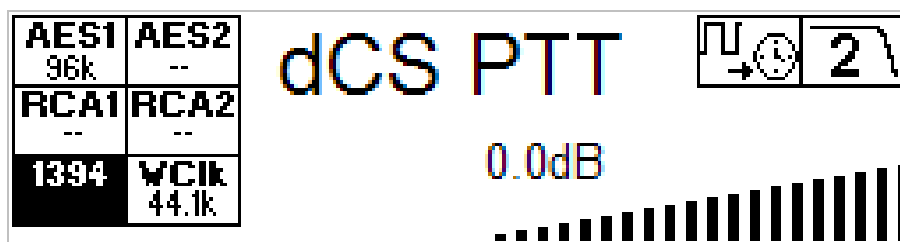

The “staircase” icon in the lower right corner gives a visual indication of the **Volume** or **Balance** setting, with the setting shown in text as well (**0.0dB** is shown).

When set to receive Dual AES data, the display will be similar to the example below.

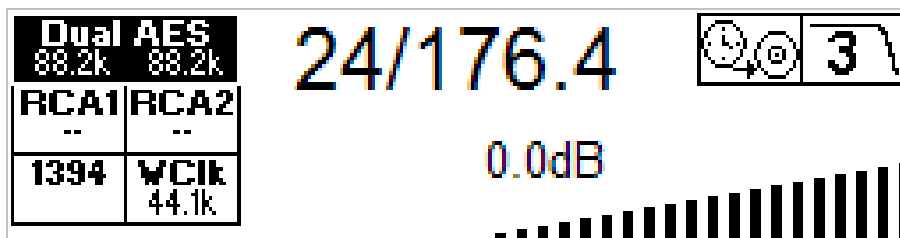

The input indicator has changed to show that the **Dual AES** input is selected and that **88.2kS/s** data streams have been detected on the **AES1** and **AES2** connectors. The central section shows that these are being used together as a **24** bit, **176.4kS/s** data stream. In this example, the icons in the top right corner indicate that the DAC is in Master mode and Filter 3 is selected.

Details of the menu displays are shown in the Menu section on page **17**.

If the display is turned off on the **Display Settings / Display Off** menu page, the LED (L) above the display lights.

## Rotary Control

The Rotary Control (N) usually controls the **Volume** setting.

When the **Balance** menu page is open, it adjusts the channel **Balance** instead.

If the menu is open, the Rotary Control pages forward and backwards through the menu.

## REAR PANEL

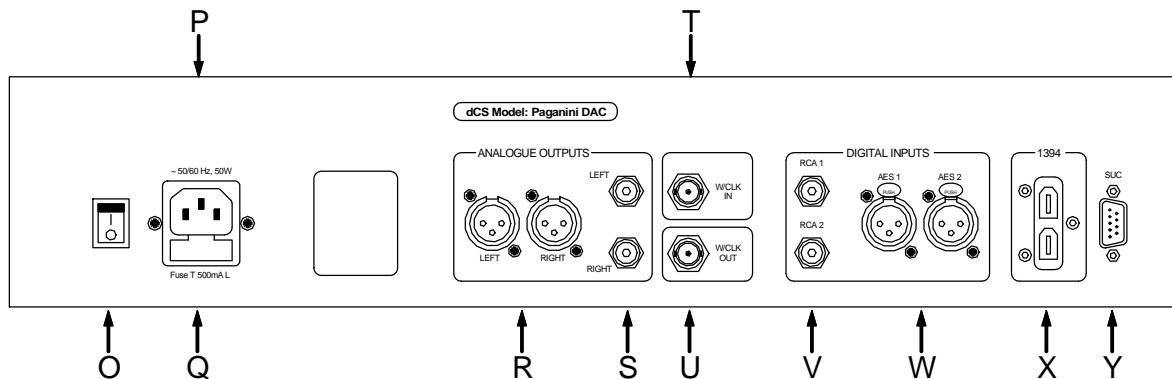

Figure 5 - Rear Panel

### Mains inlet

Power is connected via a standard IEC320 connector (P), protected by a fuse (Q) and isolated by a 2-pole power switch (O).

### Analogue Outputs

The unit features separately buffered **Balanced Outputs** (R) on XLR connectors and **Unbalanced Outputs** (S) on RCA connectors. The **Balanced Outputs** should be connected to true balanced inputs only. If your preamplifier / power amplifier has unbalanced inputs (even if the inputs are on XLR connectors), please use the **Unbalanced Outputs** instead.

### Word Clock Input / Output

The **W/Clk In** connector (T) will accept standard word clock from the source equipment or a master clock at 32, 44.1, 48, 88.2 or 96kHz. The clock frequency **MUST** be an exact multiple of the data rate, otherwise the system will not lock. Use the **Sync** button to lock the DAC to the external word clock. Note that the source **MUST** be locked to the same clock, otherwise the system will not be synchronised and periodic clicks will be heard on the outputs.

When the unit is set to Master mode, the DAC uses its internal clock instead of locking to the data or **W/Clk Input**, and the **W/Clk Out** connector (U) carries a 44.1kHz word clock. This **MUST** be connected to the source equipment, so that the entire system is synchronised to this clock.

Word clock is used for synchronisation only, it does not carry digital data.

### SPDIF Digital Inputs

The unit features 2 co-ax SPDIF inputs, labelled **RCA1** or **RCA2** (V). These inputs will accept sample rates up to 96kS/s.

### AES Digital Inputs

The **AES1** and **AES2** inputs (W) can be used individually at sample rates up to 96kS/s. If the **Dual AES** menu page is set to **On** or **Auto**, they can be used together as a **Dual AES** pair at 88.2, 96, 176.4 or 192kS/s. For Dual AES mode to work correctly, the source must actually generate Dual AES data, not just single AES on 2 connectors (which gives a mono output)!

### 1394 Interface

The IEEE 1394 interface (X) will accept encrypted DSD data from the *Paganini* Transport, as well as from other *dCS* transports and upsamplers that are loaded with current software. 1394 interfaces are great for carrying lots of digital data - but are very poor at transmitting a stable clock, so a separate Word Clock connection is required. The two 1394 ports are identical – they can be used as data inputs or as a loop-through. Note that the 1394 bus must not be connected in a loop as this will prevent the system initialising.

### SUC Connector

The **SUC** connector (Y) is an RS232 interface, primarily used to remotely control the unit during automated testing. Please contact *dCS* for advice on using this interface with a household automation system. Note that we recommend using infra-red remote control instead.

## THE MENU

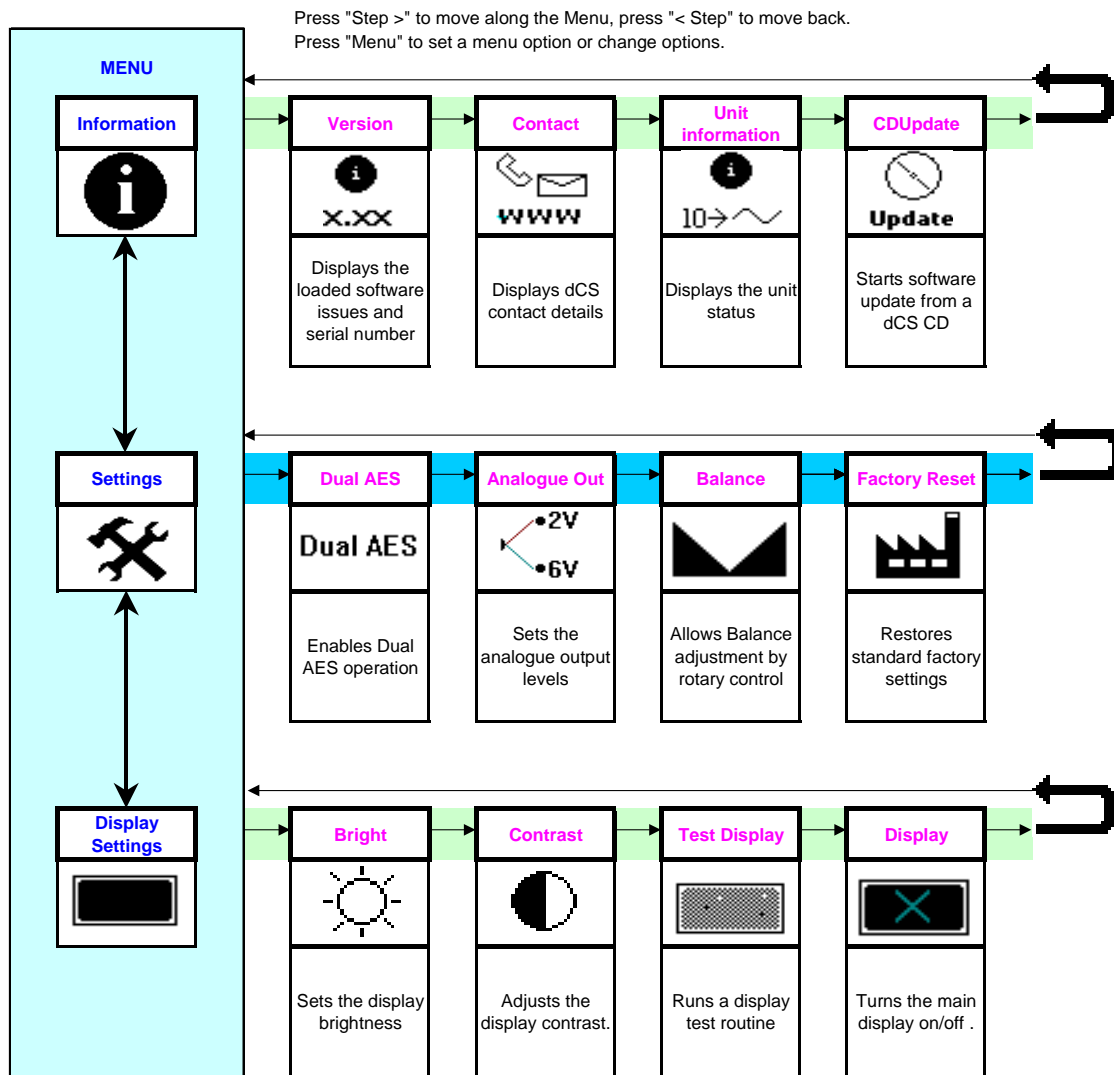

Figure 6 – The menu sequence

## Using the Menu

The menu gives the user access to a range of additional features. It also allows new features and performance enhancements to be added at a later date by software upgrades.

The menu is controlled by four buttons.



Press the **MENU** button to open the menu or select a setting.  
Press the **>** button to page forward through the menu.  
Press the **<** button to page backward through the menu.  
Press the **POWER** button to close the menu or just wait 5 seconds.

Use the Menu Guide sheet to help you find the right menu.

Each unit in the range has either three or four top-level menu pages:



The **INFORMATION** menu gives software issues, serial number, contact details and unit set-up details.



The **SETTINGS** menu allows you to set some features that are not directly accessible from the front panel.



The **DISPLAY SETTINGS** menu is used to adjust and test the display.

Use the **>** button to move the highlight to the menu you want, then press the **MENU** button to select it. The next menu level down is displayed. Use the **>** button to move the highlight to the menu page you want, then press the **MENU** button to display the information or change the setting.



Select the exit icon to go back to the previous menu level.

## INFORMATION Menu

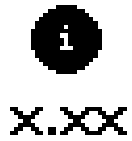

The **Version** page displays the software versions loaded in the unit and the full serial number. Please have this information ready if you contact your dealer for any reason.

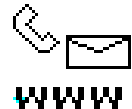

The **Contact** page displays *dCS* web-site URL, email address, telephone and fax numbers. If you have any difficulty, please contact your dealer for help first.



The **DAC Information** page displays the unit status:

- Input selected to ....
- 1394 nodes connected: ....
- Sync to Audio / Clk / Master
- Unlocked / Locked at .... kS/s
- Input is PCM / DSD
- Filter ....
- Internal temperature ....°C

Use the rotary control to scroll down the list and press the **MENU** button to exit.



The **CD Update** feature allows you to load new software into your system from either a *Paganini* transport or any STANDARD CD player or transport. Note that some non-Red-Book CD transports change the digital data and cannot be used to download new software. Please follow the instructions supplied with the update CD carefully.

If the selected input is NOT locked to CD data (16 bits at 44.1kS/s), CD Updating is not possible and the icon will be greyed out. Use the front panel controls during an update as the remote control may not operate.



If you accidentally start a CD Update, switch off the unit at the back panel switch, wait 10 seconds, then switch on again.

## DAC SETTINGS Menu

### Dual AES

This setting allows the two AES inputs to be used together to accept PCM data at high sample rates (88.2, 96, 176.4 or 192kS/s) from a Dual AES source. Note that a source with two AES outputs might not actually produce Dual AES data! The settings are:

- **Auto** – The unit detects the format flags in the digital data and automatically sets the **AES1 & 2** inputs to Single AES or Dual AES mode as required. This is the usual setting. Note that if the format flag in the data is wrong, you will need to manually select the correct setting.
- **Off** – Dual AES mode is disabled.
- **On** – Dual AES mode can be manually selected using the **INPUT** button or the remote control.

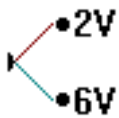

Sets the **Output Level** to **2V** rms or **6V** rms at full scale. When you set up your system, choose the **Output Level** setting that gives a comfortable listening level with the **Volume** set between **-10dB** and **-20dB**. The difference between the two settings is about 10dB.



In **Balance** mode, the operation of the rotary control changes to adjust the **Balance**. Each channel can be varied from **0dB** to **-6dB** in 0.1dB steps, then mute ( $-\infty$ ) below that. **Balance** adjustment ends after this menu page closes or the **MENU** button is pressed.



The **Factory Reset** menu page resets the unit to standard settings. These are:

**Volume** to **-30dB**.  
**Balance** to centre.  
**Input** to **AES1**.  
**Sync** to **Audio** Input.  
**Filter** to 1.

**Dual AES** to **Auto**.  
**Output Level** to **6V**.  
**Display** to On.  
**Brightness** to maximum.  
**Contrast** to 60%.

## DISPLAY SETTINGS Menu

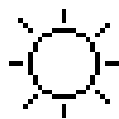

Set the display **Brightness** to a comfortable level using the **<** and **>** buttons.



Set the display **Contrast** to a comfortable level using the **<** and **>** buttons.

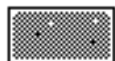

Runs a **Display Test** routine, which flashes all the indicators and the main display.



**Display On / Off**.

## SPECIFICATION

<b>Converter type</b>	5-bit, 2.822 or 3.07MS/s oversampled, <i>dCS</i> patented <i>Ring DAC</i> topology. All data is oversampled to this format before conversion to analogue.										
<b>Digital inputs</b>	<p>IEEE 1394 interface on 2x 6-way connectors. The interface accepts <i>dCS</i>-encrypted DSD (1 bit data at 2.822MS/s) from up to 4 sources.</p> <p>2x AES/EBU on 3-pin female XLR connectors. Each will accept PCM at 32 - 96kS/s up to 24 bits, <b>OR</b> as a Dual AES pair at 88.2, 96, 176.4 or 192kS/s up to 24 bits.</p> <p>2x SPDIF on 2x RCA Phono. Each will accept PCM at 32 - 96kS/s up to 24 bits.</p>										
<b>Clocking</b>	<p>Word Clock Input on 1x BNC connector, accepts standard word clock at 32, 44.1, 48, 88.2 or 96kHz. The data rate can be the same as the clock rate or an exact multiple (0.5x, 1x, 2x, 4x) of the clock rate. Sensitive to TTL levels.</p> <p>Word Clock Output on 1x BNC connector. In Master mode, a TTL-compatible 44.1kHz word clock is available on this output, it is not temperature compensated.</p>										
<b>Frequency response (set to Filter 1)</b>	<table> <tr> <td>Fs = 32kS/s</td> <td>+0.1/-0.5dB, 10Hz to 15kHz</td> </tr> <tr> <td>Fs = 44.1 or 48kS/s</td> <td>+/-0.1dB, 10Hz to 20kHz</td> </tr> <tr> <td>Fs = 88.2 or 96kS/s</td> <td>+/-0.1dB, 10Hz to 20kHz</td> </tr> <tr> <td>Fs = 176.4 or 192kS/s</td> <td>+/-0.1dB, 10Hz to 20kHz</td> </tr> <tr> <td>DSD</td> <td>+/-0.1dB, 10Hz to 20kHz</td> </tr> </table>	Fs = 32kS/s	+0.1/-0.5dB, 10Hz to 15kHz	Fs = 44.1 or 48kS/s	+/-0.1dB, 10Hz to 20kHz	Fs = 88.2 or 96kS/s	+/-0.1dB, 10Hz to 20kHz	Fs = 176.4 or 192kS/s	+/-0.1dB, 10Hz to 20kHz	DSD	+/-0.1dB, 10Hz to 20kHz
Fs = 32kS/s	+0.1/-0.5dB, 10Hz to 15kHz										
Fs = 44.1 or 48kS/s	+/-0.1dB, 10Hz to 20kHz										
Fs = 88.2 or 96kS/s	+/-0.1dB, 10Hz to 20kHz										
Fs = 176.4 or 192kS/s	+/-0.1dB, 10Hz to 20kHz										
DSD	+/-0.1dB, 10Hz to 20kHz										
<b>Residual noise</b>	Better than -110dB0, 20Hz - 20kHz unweighted.										
<b>Spurious responses</b>	Better than -100dB0, 20Hz - 20kHz.										
<b>L-R crosstalk</b>	Better than -80dB0, 20Hz - 20kHz.										
<b>Output levels</b>	2V rms or 6V rms on all outputs for a full-scale input, set in the menu.										
<b>Balanced outputs</b>	1 stereo pair on 2x 3-pin male XLR connectors (pin 2 = hot, pin 3 = cold). These outputs are electronically balanced and floating, the signal balance ratio at 1kHz is better than 40dB. Output impedance is 3Ω, maximum load is 600Ω (a 10kΩ load is recommended).										
<b>Unbalanced outputs</b>	1 stereo pair on 2x RCA Phono connectors. Output impedance is 52Ω, maximum load is 600Ω (a 10kΩ load is recommended).										
<b>Size and weight</b>	<p>460mm (18.0") W x 420mm (16.5") D x 113mm (4.4") H including feet. Allow extra depth for cable connectors.</p> <p>Weight 11.0kg (24.2lbs).</p>										
<b>Power requirements</b>	<p>Internally set to either 100, 115/120, 220 or 230/240V AC, 49 – 62Hz.</p> <p>Power consumption: 24W typical, 30W maximum.</p>										

These specifications are subject to change without notice.

## MAINTENANCE AND SUPPORT

### Service and Maintenance

dCS audio products are designed not to need regular maintenance, and contain no user serviceable parts apart from the mains fuse. If your unit is damaged in any way, please contact your dealer.

### Replacing a Blown Mains Fuse

There is a mains fuse below the power inlet, accessible from the outside of the unit. If the fuse blows, it may be changed by the user. The current consumption of the unit is very low, so it only blows if power surges occur, or there is a fault in the unit. Usually power surges cause no other damage, but if the fuse blows repeatedly on replacement, some other damage will have been done and the unit will need to be repaired.

Fuse type: 20mm x 5mm T0.5 amp L fuse



If the fuse should fail, it is essential that it is replaced with one of the same type and rating. Failure to do so could result in damage to the unit, risk of fire or electric shock and will invalidate the warranty.

Referring to the diagram below, remove the power cable, use a small flat bladed screwdriver to pry up the tab on the fuse carrier (A) and pull it out. Push the blown fuse out of the clip in the carrier (B) and dispose of it. Fit a new fuse in the clip (C) and push the carrier back into the unit so that it clicks home. Spare fuses are provided with the unit.

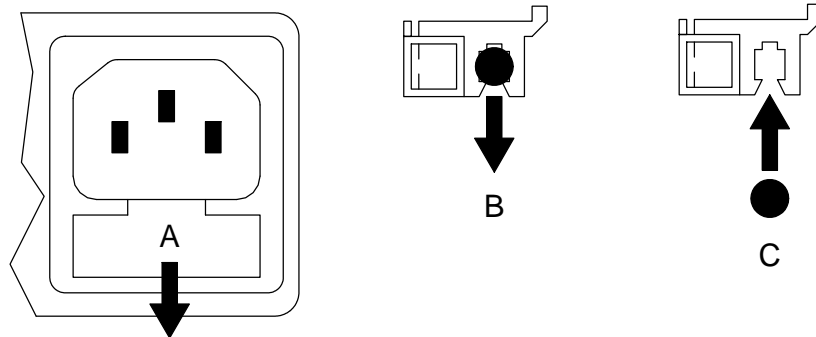

### Cleaning the case

The front panel of your dCS equipment is machined from very high grade aluminium. Great care has been taken to create the finish of the aluminium throughout the engineering process from the raw solid material to the finished piece.

To remove loose dust or finger marks from the case, we recommend that you use a clean, dry, lint-free cloth.

To restore the finish on the front panel, we recommend applying small quantities of a lanolin based cleaner, using a clean, dry, lint-free cloth and then wiping off. Do not allow lanolin to collect around the buttons.

Small amounts of glass cleaner containing ammonia may be used to clean other surfaces, but avoid spraying onto the connector contacts.

## Limited Warranty

### General

dCS warrants this product against defects in materials and workmanship for a period of 3 years from the date the unit was originally shipped from dCS. During the warranty period, dCS will repair or, at our absolute discretion, replace a faulty product. Warranty repairs must only be carried out by dCS or our authorised service agents. Please contact your dealer if your unit requires service.

Your dealer should have completed on your behalf an **Owner Registration** form at the time of sale and returned it to dCS. On receipt of the Owner Registration form, dCS will add your contact details to our customer database. dCS will use this information for warranty purposes only, we will not contact you directly for reasons relating to sales and marketing.

This warranty applies to the original owner.

### Warranty Exclusions

The Warranty does not cover wear and tear.

The Warranty on this product will be void if:

- the product is misused in any way.
- any unauthorised modifications or repairs are carried out.
- the product is not used in accordance with the Operating Conditions stated in this manual.
- the product is serviced or repaired other than by dCS or our authorised service agents.
- the product is operated without a mains earth (or ground) connection.
- the unit is returned inadequately packed.

dCS reserve the right to apply a service charge if a product returned for warranty repair is found to be operating correctly, or if a product is returned without a returns number being issued.

This warranty covers parts and labour only, it does not cover shipping charges or tax/duty.

Our dealers or distributors are NOT authorised to extend the terms of this warranty, dCS cannot accept responsibility for any attempt to do so.

Products re-sold by dCS on a "used" basis may be subject to reduced warranty terms.

### Obtaining Service

Should you encounter a problem, contact your authorised dCS dealer for advice, quoting the model, the full serial number, software version number, and giving a detailed description of the fault. Your dealer will advise you fully on actions that need to be taken. When returning a unit, the original packaging should be used to avoid transit damage. Replacement packaging sets may be purchased from dCS.

During the Warranty period, there will normally be no charge for parts or labour.

### Operating Conditions

- The supply voltage must remain within +/-10% of the A.C. voltage specified on the back panel.
- The supply frequency must be in the range 49Hz to 62Hz.
- Ambient temperature range: 0°C (32°F) to 40°C (104°F), non-condensing.
- Do not install the unit near heat sources such as radiators, air ducts, power amplifiers or direct strong sunlight.
- If in doubt, the easy test is – the unit is happy to work anywhere a human is.

## If you need more help

In the first instance, you should contact your dealer. If they cannot resolve the issue, contact your national distributor.

Manufactured by:

dCS Ltd  
Mull House  
Great Chesterford Court  
Great Chesterford  
Saffron Walden CB10 1PF  
UK

[www.dcsLtd.co.uk](http://www.dcsLtd.co.uk)

This user manual may be downloaded free of charge from our web-site.

A bound copy of this manual may be ordered from *dCS*.

## Software History

*dCS* products make extensive use of software configurable chips – FPGAs and DSPs. This gives us the ability to update our products to add extra features, update digital interface standards or make performance improvements by loading new software. Occasionally, a hardware upgrade may be necessary also to increase the “capacity” of the electronics, add extra connectors or extra front panel controls.

Please note that not all software updates make an earth-shattering change. You should have a clear idea of what you expect to gain before updating to the latest issue. We recommend that you keep your software up to date. Check the *dCS* web-site for the latest software updates.

This manual is for *Paganini DAC* software version 1.0x.

Issue 1.00 - The first issue.